

ENG

ITA

Food&Beverage

Impulse

Catalog
Catalogo

ENG

ITA

Food&Beverage

Impulse

Catalog Catalogo

4	Isetta LX/ST	
8	Isabella LX	
10	Fiji LX	
14	Bermuda LX	
16	Bermuda View	
18	Il Carrettino Classic	
20	Il Carrettino Carapine	
22	Il Gelataio 4/8	
24	Metro ST	
26	Metro ST Self	
28	Maxi	
30	Galaxy TB	
32		Maxivision
34		Marin TB
36		Tornado TB
38		Tornado TN
40		Tornado 100 TN-TB
42		Mistral TB
44		Mistral TN
46		Sky
48		Barrique
50		Action
52		Expo

Isetta LX / ST

H 117

P 76 • 80

L 4 • 6R • 7R • 9R • 12R

Gelato

	TN Chiller	TB Freezer	TB/TN Dual Temp
--	---------------	---------------	--------------------

RS-Static

RV-Ventilated

TCS-Heated

CH-Chocolate

Installation

Plug-in

Temperature

-16/-14 °C

Refrigerant

R290

Refrigeration

Static

Compressor

Hermetic

Defrost

Electric

Climate class

7

Upper class

Tempered

Front glass

Tempered

Side glass

Tempered

Rear closing system

Tilting panel

Work top

White prepainted sheet

Lighting

Led 5700 K

Equipment handling

Swivel casters

Storage cell

Static refrigerated
with skin evaporator
(except 4 model)

Installazione

Plug-in

Temperatura

-16/-14 °C

Refrigerante

R290

Refrigerazione

Statica

Compressore

Ermetico

Sbrinamento

Elettrico

Classe climatica

7

Vetro superiore

Temperato

Vetro frontale

Temperato

Vetri laterali

Temperato

Chiusura posteriore

Ribaltina basculante

Piano di servizio

Lamiera preverniciata bianca

Illuminazione

Led 5700 K

Movimentazione

Ruote pivotanti

Cella di riserva

Refrigerata statica con
evaporatore a mantello
(eccetto modello 4)



LX

Internal color

Colore interno

White

Front color

Colore frontale

White

Sides color

Colore fianchi

White



R290



ST

Isetta LX/ST Gelato

	4 LX-ST	6R LX-ST	7R LX-ST	9R LX	12R LX
External dimensions (LxDxH) Dimensioni esterne (LxPxH)	824x760x1176 mm	1184x800x1176 mm	1354x800x1176 mm	1659x800x1176 mm	2119x800x1176 mm
Capacity (gross/net) Capacità (lorda/netta)	-	-	-	-	-
Net weight Peso netto	69 kg	97 kg	102 kg	160 kg	217 kg
Refrigeration Refrigerazione	Statica Static				
Refrigerant Refrigerante	R290				
Climate class Classe climatica	7				
Operating conditions Condizioni ambientali	35 °C / 75 %RH				
Product temperature Temperatura prodotto	-16/-14 °C				
Compressor (q.ty - type) Compressore (q.tà - tipologia)	1 - Hermetic 1 - Ermetico				2 - Hermetics 2 - Ermetici
Defrost Sbrinamento	Electric Elettrico				
Power supply Alimentazione	230 V / 1 Ph / 50 Hz				
Electrical input (nominal) Assorbimento elettrico (regime)	330 W / 2,3 A	470 W / 2,6 A			1045 W / 5,6 A
Electrical input (defrost) Assorbimento elettrico (sbrinamento)	880 W / 3,8 A	810 W / 3,8 A			1755 W / 8,2 A



Technical sheet about models whit condensing unit included with air cooled
Dati tecnici riferiti a modelli con unità a bordo con condensazione ad aria

Setup

Allestimento



Display

Vasca espositiva

5 Lt * 360 x 165 x 120 h		4 + (4)	6 + (6)	7 + (7)	9 + (9)	12 + (12)
4,75 Lt 260 x 157 x 170 h		6	10	11	14	19
* Piled up double row Doppia fila di riserva						

Storage cell

Cella di riserva

5 Lt * 360 x 165 x 120 h		-	4 + (4)	6 + (6)	7 + (7)	10 + (10)
4,75 Lt 260 x 157 x 170 h		-	6	8	10	14
* Piled up double row Doppia fila di riserva						

Item

Accessorio

White cone holder Portaconi completo bianco	•
Scoop washer with stainless steel container Lavaporzionatore vaschetta inox	•

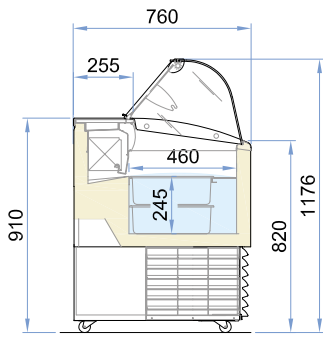

LX
4

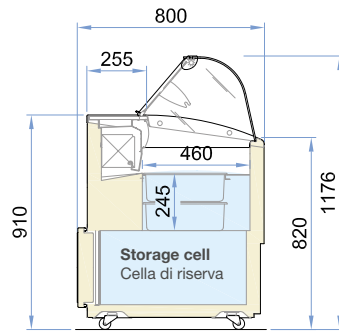

LX
6R, 7R, 9R, 12R

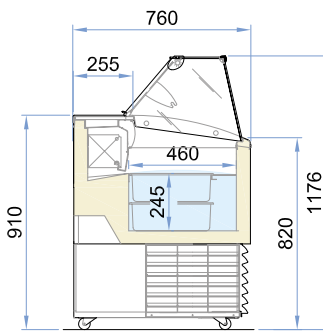

ST
4

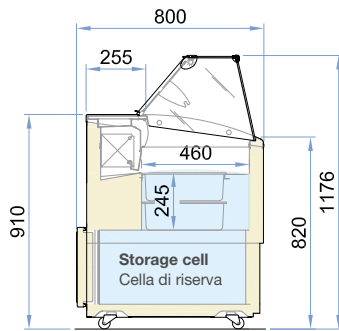

ST
6R, 7R

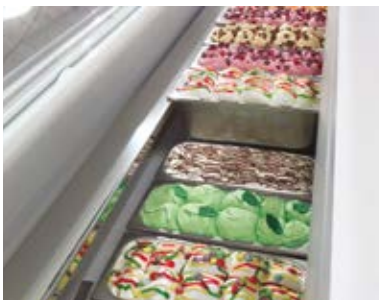

Display - piled up double row - 5 Lt
Vasca espositiva - doppia fila di riserva - 5 Lt



Storage cell - mod.: 6R, 7R, 9R, 12R
Cella di riserva - mod.: 6R, 7R, 9R, 12R

Isabella LX

H 137
P 90
L 10 • 13

Gelato

	TN Chiller	TB Freezer	TB/TN Dual Temp
RS-Static		•	
RV-Ventilated			
TCS-Heated			
CH-Chocolate			

Installation
Plug-in

Temperature
-16/-14 °C

Refrigerant
R290

Refrigeration
Static

Compressor
Hermetic

Defrost
Hot gas

Climate class
4

Upper class
Tempered

Front glass
Tempered

Side glass
Tempered

Rear closing system
Self-rolling curtain

Work top
White prepainted sheet

Lighting
Led 5700 K

Equipment handling
Swivel casters with brake

Storage cell
Static refrigerated
with skin evaporator

Installazione
Plug-in

Temperatura
-16/-14 °C

Refrigerante
R290

Refrigerazione
Statica

Compressore
Ermetico

Sbrinamento
Gas caldo

Classe climatica
4

Vetro superiore
Temperato

Vetro frontale
Temperato

Vetri laterali
Temperato

Chiusura posteriore
Tenda manuale autoavvolgente

Piano di servizio
Lamiera preverniciata bianca

Illuminazione
Led 5700 K

Movimentazione
Ruote pivotanti con freno

Cella di riserva
Refrigerata statica con
evaporatore a mantello

Internal color
Colore interno

White

Sides color
Colore fianchi

Grigio E_Z065



R290

PM_AD1

Front sticker
Adesivo frontale

Isabella LX

10
13

External dimensions (LxDxH) Dimensioni esterne (LxPxH)	1317x906x1372 mm	1647x906x1372 mm
Capacity (gross/net) Capacità (lorda/netta)	-	-
Net weight Peso netto	132 kg	192 kg
Refrigeration Refrigerazione	Statica Static	
Refrigerant Refrigerante	R290	
Climate class Classe climatica	4	
Operating conditions Condizioni ambientali	30 °C / 55 %RH	
Product temperature Temperatura prodotto	-16/-14 °C	
Compressor (q.ty - type) Compressore (q.tà - tipologia)	1 - Hermetic 1 - Ermetico	2 - Hermetics 2 - Ermetici
Defrost Sbrinamento	Hot gas Gas caldo	
Power supply Alimentazione	230 V / 1 Ph / 50 Hz	
Electrical input (nominal) Assorbimento elettrico (regime)	590 W / 3 A	980 W / 5,1 A
Electrical input (defrost) Assorbimento elettrico (sbrinamento)	1110 W / 5,2 A	1240 W / 5,8 A



Technical sheet about models whit condensing unit included with air cooled
Dati tecnici riferiti a modelli con unità a bordo con condensazione ad aria

Setup

Allestimento

Display



Vasca espositiva

5 Lt * 360 x 165 x 120 h		10 + (10)	13 + (13)
4,75 Lt 260 x 157 x 170 h		17	18

* Piled up double row Doppia fila di riserva

Storage cell

Cella di riserva

5 Lt * 360 x 165 x 120 h		5 + (5)	7 + (7)
4,75 Lt 260 x 157 x 170 h		8	10

* Piled up double row Doppia fila di riserva

Item

Accessorio

White cone holder Portaconi completo bianco	•
Scoop washer with stainless steel container Lavaporzionatore vaschetta inox	•



Display - piled up double row - 5 Lt
Vasca espositiva - doppia fila di riserva - 5 Lt



Storage cell
Cella di riserva

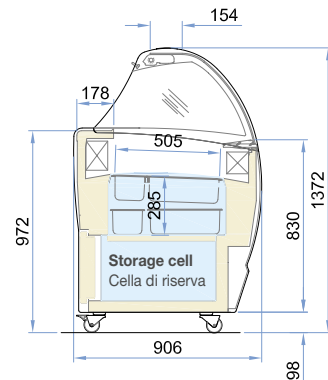

Fiji LX

H 125

P 63 • 78

L 4 • 6 • 7 • 9 • 120 • 140

Gelato

	TN Chiller	TB Freezer	TB/TN Dual Temp
RS-Static			
RV-Ventilated		•	
TCS-Heated			
CH-Chocolate			

Installation
Plug-in

Temperature
-16/-14 °C

Refrigerant
R404A

Refrigeration
Ventilated

Compressor
Hermetic

Defrost
Hot gas

Climate class
7

Upper class
Tempered

Front glass
Tempered

Side glass
Tempered

Rear closing system
Tilting panel

Work top
White prepainted sheet

Lighting
Led 5700 K

Equipment handling
Swivel casters with brake

Installazione
Plug-in

Temperatura
-16/-14 °C

Refrigerante
R404A

Refrigerazione
Ventilata

Compressore
Ermetico

Sbrinamento
Gas caldo

Classe climatica
7

Vetro superiore
Temperato

Vetro frontale
Temperato

Vetri laterali
Temperato

Chiusura posteriore
Ribaltina basculante

Piano di servizio
Lamiera preverniciata bianca

Illuminazione
Led 5700 K

Movimentazione
Ruote pivotanti con freno

Internal color
Colore interno

White

Front color
Colore frontale

White

Sides color
Colore fianchi

White





Fiji LX

	4	6	7	9
External dimensions (LxDxH) Dimensioni esterne (LxPxH)	824x630x1247 mm	1214x630x1247 mm	1354x630x1247 mm	1659x630x1247 mm
Capacity (gross/net) Capacità (lorda/netta)	218 / 119 Lt	339 / 185 Lt	383 / 209 Lt	478 / 261 Lt
Net weight Peso netto	67 kg	99 kg	110 kg	135 kg
Refrigeration Refrigerazione	Ventilated Ventilata			
Refrigerant Refrigerante	R290			
Climate class Classe climatica	7			
Operating conditions Condizioni ambientali	35 °C / 75 %RH			
Product temperature Temperatura prodotto	-16/-14 °C			
Compressor (q.ty - type) Compressore (q.tà - tipologia)	1 - Hermetic 1 - Ermetico			
Defrost Sbrinamento	Hot gas Gas caldo			
Power supply Alimentazione	230 V / 1 Ph / 50 Hz			
Electrical input (nominal) Assorbimento elettrico (regime)	555 W / 2,5 A	900 W / 4,1 A		980 W / 4,5 A
Electrical input (defrost) Assorbimento elettrico (sbrinamento)	1425 W / 6,5 A	1860 W / 7,5 A		1960 W / 8,3 A

Technical sheet about models whit condensing unit included with air cooled
Dati tecnici riferiti a modelli con unità a bordo con condensazione ad aria

Setup

Allestimento

5 Lt * 360 x 165 x 120 h		4 + (4)	6 + (6)	7 + (7)	9 + (9)
4,75 Lt 260 x 157 x 170 h		4	6	7	9

* Piled up double row Doppia fila di riserva

Item

Accessorio

White cone holder Portaconi completo bianco	•
Scoop washer with stainless steel container Lavaporzionatore vaschetta inox	•

120	140
------------	------------

1214x785x1247 mm	1354x785x1247 mm
459 / 243 Lt	518 / 274 Lt
110 kg	135 kg
Ventilated Ventilata	
R290	
7	
35 °C / 75 %RH	
-16/-14 °C	
1 - Hermetic 1 - Ermetico	
Hot gas Gas caldo	
230 V / 1 Ph / 50 Hz	
950 W / 4,3 A	1000 W / 4,5 A
2000 W / 8 A	2050 W / 8,4 A



Display - piled up double row - 5 Lt
Vasca espositiva - doppia fila di riserva - 5 Lt

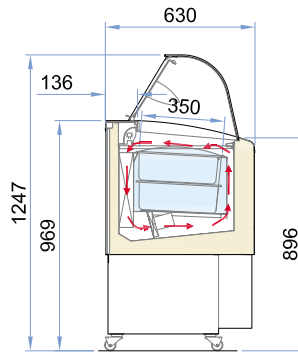

4 - 6 - 7 - 9

9 + (9)	10 + (10)
12	14

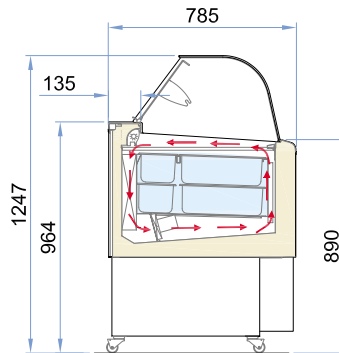

120 - 140

•
•

Bermuda LX

H 134
P 80
L 10 • 13

Gelato

	TN Chiller	TB Freezer	TB/TN Dual Temp
RS-Static			
RV-Ventilated		•	
TCS-Heated			
CH-Chocolate			

Installation
Plug-in

Temperature
-16/-14 °C

Refrigerant
R290

Refrigeration
Ventilated

Compressor
Hermetic

Defrost
Hot gas

Climate class
4

Upper class
Tempered

Front glass
Heated

Side glass
Tempered

Rear closing system
Self-rolling curtain

Work top
Prepainted sheet
Grey RAL 9006

Lighting
Led 5700 K

Equipment handling
Swivel casters with brake

Storage cell
Static refrigerated
with skin evaporator

Installazione
Plug-in

Temperatura
-16/-14 °C

Refrigerante
R290

Refrigerazione
Ventilata

Compressore
Ermetico

Sbrinamento
Gas caldo

Classe climatica
4

Vetro superiore
Temperato

Vetro frontale
Riscaldato

Vetri laterali
Temperato

Chiusura posteriore
Tenda manuale autoavvolgente

Piano di servizio
Lamiera preverniciata
Grigio RAL 9006

Illuminazione
Led 5700 K

Movimentazione
Ruote pivotanti con freno

Cella di riserva
Refrigerata statica con
evaporatore a mantello

Internal color
Colore interno

White

Sides color
Colore fianchi

Grigio E_Z065



R290

PM_AD7_BM

Front sticker (standard)
Adesivo frontale

Bermuda LX

10
13

External dimensions (LxDxH) Dimensioni esterne (LxPxH)	1340x799x1343 mm	1670x799x1343 mm
Capacity (gross/net) Capacità (lorda/netta)	300 / 255 Lt	395 / 325 Lt
Net weight Peso netto	190 kg	200 kg
Refrigeration Refrigerazione	Ventilated Ventilata	
Refrigerant Refrigerante	R290	
Climate class Classe climatica	4	
Operating conditions Condizioni ambientali	30 °C / 55 %RH	
Product temperature Temperatura prodotto	-16/-14 °C	
Compressor (q.ty - type) Compressore (q.tà - tipologia)	1 - Hermetic 1 - Ermetico	2 - Hermetics 2 - Ermetici
Defrost Sbrinamento	Hot gas Gas caldo	
Power supply Alimentazione	230 V / 1 Ph / 50 Hz	
Electrical input (nominal) Assorbimento elettrico (regime)	770 W / 4,3 A	1340 W / 6,7 A
Electrical input (defrost) Assorbimento elettrico (sbrinamento)	1410 W / 6,9 A	2200 W / 10,4 A

Technical sheet about models whit condensing unit included with air cooled
Dati tecnici riferiti a modelli con unità a bordo con condensazione ad aria



Storage cell
Cella di riserva

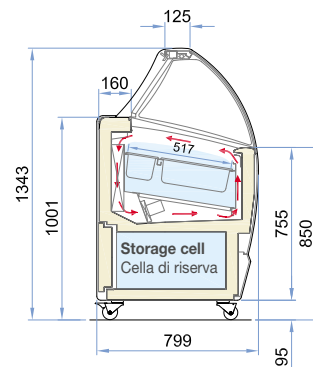



Setup

Allestimento



Display

Vasca espositiva

5 Lt 360 x 165 x 120 h		10	13
4,75 Lt 260 x 157 x 170 h		14	18

Storage cell

Cella di riserva

5 Lt * 360 x 165 x 120 h		4 + (4)	6 + (6)
4,75 Lt 260 x 157 x 170 h		6	8

* Piled up double row Doppia fila di riserva

Item

Accessorio

White cone holder Portaconi completo bianco	•
Scoop washer with stainless steel container Lavaporzatore vaschetta inox	•



PM_AD8_BM



PM_AD9_BM



PM_AD10_BM



PM_AD11_BM

Bermuda View

H 135
P 81
L 10 • 13

Gelato

	TN Chiller	TB Freezer	TB/TN Dual Temp
RS-Static			
RV-Ventilated		•	
TCS-Heated			
CH-Chocolate			

Installation
Plug-in

Temperature
-16/-14 °C

Refrigerant
R290

Refrigeration
Ventilated

Compressor
Hermetic

Defrost
Hot gas

Climate class
7

Upper class
Tempered

Front glass
Heated

Side glass
Tempered

Opening system
Downward-opening

Rear closing system
Self-rolling curtain

Work top
Prepainted sheet
Grey RAL 9006

Lighting
Led 5700 K

Equipment handling
Swivel casters
with brake

Storage cell
Static refrigerated
with skin evaporator

Installazione
Plug-in

Temperatura
-16/-14 °C

Refrigerante
R290

Refrigerazione
Ventilata

Compressore
Ermetico

Sbrinamento
Gas caldo

Classe climatica
7

Vetro superiore
Temperato

Vetro frontale
Riscaldato

Vetri laterali
Temperato

Apertura anteriore
Apertura manuale
verso il basso

Chiusura posteriore
Tenda manuale autoavvolgente

Piano di servizio
Lamiera preverniciata
Grigio RAL 9006

Illuminazione
Led 5700 K

Movimentazione
Ruote pivotanti
con freno

Cella di riserva
Refrigerata statica con
evaporatore a mantello

Internal color
Colore interno

White

Front color
Colore frontale

White

Sides color
Colore fianchi

White



R290

Bermuda View

10
13

External dimensions (LxDxH) Dimensioni esterne (LxPxH)	1340x814x1354 mm	1670x814x1354 mm
Capacity (gross/net) Capacità (lorda/netta)	300 / 255 Lt	395 / 325 Lt
Net weight Peso netto	195 kg	235 kg
Refrigeration Refrigerazione	Ventilated Ventilata	
Refrigerant Refrigerante	R290	
Climate class Classe climatica	7	
Operating conditions Condizioni ambientali	35 °C / 75 %RH	
Product temperature Temperatura prodotto	-16/-14 °C	
Compressor (q.ty - type) Compressore (q.tà - tipologia)	2 - Hermetics 2 - Ermetici	
Defrost Sbrinamento	Hot gas Gas caldo	
Power supply Alimentazione	230 V / 1 Ph / 50 Hz	
Electrical input (nominal) Assorbimento elettrico (regime)	1250 W / 5,8 A	1600 W / 8 A
Electrical input (defrost) Assorbimento elettrico (sbrinamento)	1360 W / 6,6 A	2000 W / 10 A

Technical sheet about models whit condensing unit included with air cooled
Dati tecnici riferiti a modelli con unità a bordo con condensazione ad aria

Setup

Allestimento

Display

Vasca espositiva

5 Lt 360 x 165 x 120 h		10	13
----------------------------------	---	----	----

Storage cell

Cella di riserva

5 Lt 360 x 165 x 120 h		4	6
----------------------------------	---	---	---

Item

Accessorio

White cone holder Portaconi completo bianco	•
Scoop washer with stainless steel container Lavaporzionate vaschetta inox	•



Storage cell
Cella di riserva

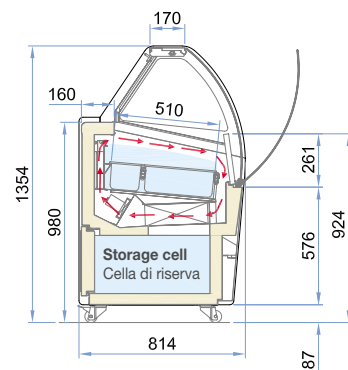

Il Carrettino Classic

H 208
P 128
L 200

Gelato

	TN Chiller	TB Freezer	TB/TN Dual Temp
RS-Static			
RV-Ventilated		•	
TCS-Heated			
CH-Chocolate			

Installation

Plug-in

Configuration

- Scoop washer with water tap
- Tanks for water
- Sun curtain

Temperature

-16/-14 °C

Refrigerant

R290

Refrigeration

Ventilated

Compressor

Hermetic

Defrost

Hot gas

Climate class

4

Upper class

Tempered single

Front glass

Tempered single

Side glass

Tempered single

Rear closing system

Tilting panel

Work top

Stainless steel

Lighting

Led 5700 K

Equipment handling

2 Ray wheels and
one pivoting wheel with brake

Installazione

Plug-in

Configurazione

- Lavaporzionatore con rubinetto
- Taniche per acqua
- Tenda decorativa parasole

Temperatura

-16/-14 °C

Refrigerante

R290

Refrigerazione

Ventilata

Compressore

Ermetico

Sbrinamento

Gas caldo

Classe climatica

4

Vetro superiore

Singolo temperato

Vetro frontale

Singolo temperato

Vetri laterali

Singolo temperato

Chiusura posteriore

Ribaltina basculante

Piano di servizio

Acciaio inox

Illuminazione

Led 5700 K

Movimentazione

Ruote con raggi (2) + ruota (1)
pivottante con freno

Internal color

Colore interno

 Inox

Front / sides colours

Colori frontale / fianchi

 Yellow Graphic

 Brown Graphic

 White

 Black



R290

Il Carrettino



Classic

External dimensions (LxDxH) Dimensioni esterne (LxPxH)	2000x1285x2081 mm
Net weight Peso netto	205 kg
Refrigeration Refrigerazione	Ventilated Ventilata
Refrigerant Refrigerante	R290
Climate class Classe climatica	4
Operating conditions Condizioni ambientali	30 °C / 55 %RH
Product temperature Temperatura prodotto	-16/-14 °C
Compressor (q.ty - type) Compressore (q.tà - tipologia)	1 - Hermetic 1 - Ermetico
Defrost Sbrinamento	Hot gas Gas caldo
Power supply Alimentazione	230 V / 1 Ph / 50 Hz
Electrical input (nominal) Assorbimento elettrico (regime)	470 W / 2,2 A
Electrical input (defrost) Assorbimento elettrico (sbrinamento)	750 W / 3,5 A

Technical sheet about models whit condensing unit included with air cooled
Dati tecnici riferiti a modelli con unità a bordo con condensazione ad aria

Setup

Allestimento

5 Lt 360 x 165 x 120 h		6 + (6)
4,75 Lt 260 x 157 x 170 h		10

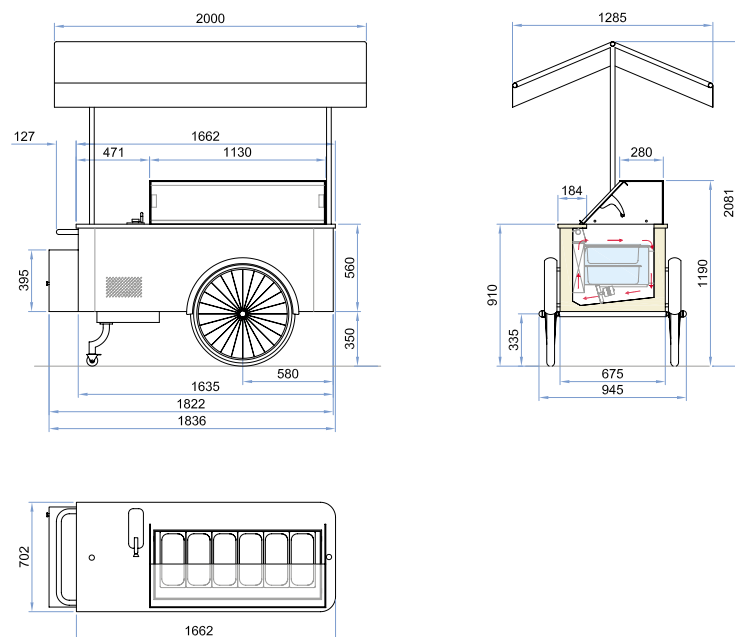

Il Carrettino Carapine

H 208
P 128
L 200

Gelato

	TN Chiller	TB Freezer	TB/TN Dual Temp
RS-Static			
RV-Ventilated		•	
TCS-Heated			
CH-Chocolate			

Installation

Plug-in

Configuration

- Scoop washer with water tap
- Tanks for water
- Sun curtain

Temperature

-16/-14 °C

Refrigerant

R290

Refrigeration

Ventilated

Compressor

Hermetic

Defrost

Hot gas

Climate class

4

Upper class

Tempered single

Front glass

Tempered single

Side glass

Tempered single

Rear closing system

Tilting panel

Work top

Stainless steel

Lighting

Led 5700 K

Equipment handling

2 Ray wheels and
one pivoting wheel with brake

Installazione

Plug-in

Configurazione

- Lavaporzionatore con rubinetto
- Taniche per acqua
- Tenda decorativa parasole

Temperatura

-16/-14 °C

Refrigerante

R290

Refrigerazione

Ventilata

Compressore

Ermetico

Sbrinamento

Gas caldo

Classe climatica

4

Vetro superiore

Singolo temperato

Vetro frontale

Singolo temperato

Vetri laterali

Singolo temperato

Chiusura posteriore

Ribaltina basculante

Piano di servizio

Acciaio inox

Illuminazione

Led 5700 K

Movimentazione

Ruote con raggi (2) + ruota (1)
pivottante con freno

Internal color

Colore interno

 Inox

Front / sides colours

Colori frontale / fianchi

 Yellow Graphic

 Brown Graphic

 White

 Black



R290

Il Carrettino

Carapine

External dimensions (LxDxH) Dimensioni esterne (LxPxH)	2000x1285x2081 mm
Net weight Peso netto	205 kg
Refrigeration Refrigerazione	Ventilated Ventilata
Refrigerant Refrigerante	R290
Climate class Classe climatica	4
Operating conditions Condizioni ambientali	30 °C / 55 %RH
Product temperature Temperatura prodotto	-16/-14 °C
Compressor (q.ty - type) Compressore (q.tà - tipologia)	1 - Hermetic 1 - Ermetico
Defrost Sbrinamento	Hot gas Gas caldo
Power supply Alimentazione	230 V / 1 Ph / 50 Hz
Electrical input (nominal) Assorbimento elettrico (regime)	470 W / 2,2 A
Electrical input (defrost) Assorbimento elettrico (sbrinamento)	750 W / 3,5 A

Technical sheet about models whit condensing unit included with air cooled
Dati tecnici riferiti a modelli con unità a bordo con condensazione ad aria

Setup

Allestimento

7 Lt ø 200 x 250 h	8
------------------------------	---

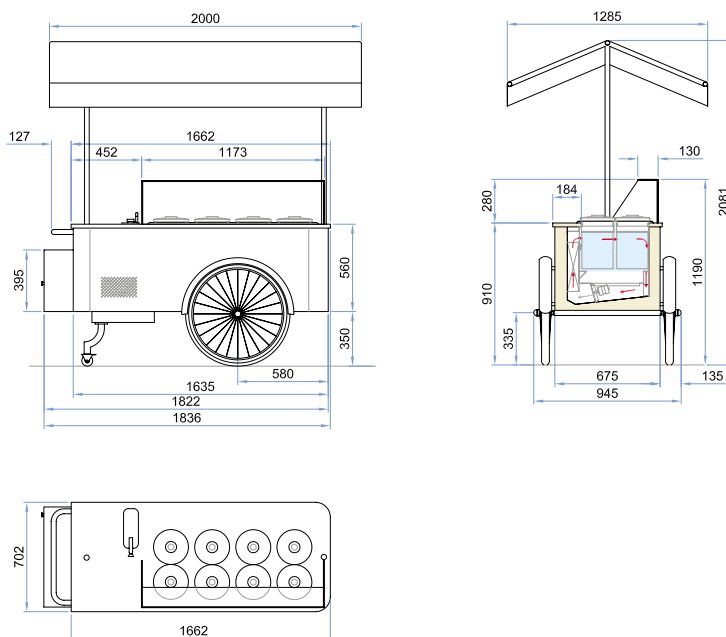

Il Gelataio 4/8

H 96

Ø 70 • 91

Gelato

	TN Chiller	TB Freezer	TB/TN Dual Temp
RS-Static		•	
RV-Ventilated			
TCS-Heated			
CH-Chocolate			

Installation

Plug-in

Configuration

- T1 - 1 temperature
- T2 - 2 temperature
- T3 - 3 temperature

Temperature

-16/-14 °C

Refrigerant

R452A

Refrigeration

Induction

Compressor

Hermetic

Defrost

Hot gas

Climate class

7

Closing system

Carapine lids

- ## Work top
- Stainless steel
 - Solid surface white

Equipment handling

Swivel casters with brake

Installazione

Plug-in

Configurazione

- T1 - 1 temperatura
- T2 - 2 temperature
- T3 - 3 temperature

Temperatura

-16/-14 °C

Refrigerante

R452A

Refrigerazione

Induzione

Compressore

Ermetico

Sbrinamento

Gas caldo

Classe climatica

7

Sistema di chiusura

Coperchi per carapine

- ## Piano di servizio
- Acciaio inox
 - Superficie solida bianca

Movimentazione

Ruote pivotanti con freno



4
Dark Gelato

Sticker
Adesivo



8
White Gelato

Sticker
Adesivo

Il Gelataio

	4	8
	T1 - T2	T1 - T2 - T3

External dimensions (LxDxH) Dimensioni esterne (LxPxH)	701x701x960 mm	910x910x960 mm
Net weight Peso netto	190 kg	200 kg
Refrigeration Refrigerazione	Induction Induzione	
Refrigerant Refrigerante	R452A	
Climate class Classe climatica	7	
Operating conditions Condizioni ambientali	35 °C / 75 %RH	
Product temperature Temperatura prodotto	-16/-14 °C	
Compressor (q.ty - type) Compressore (q.tà - tipologia)	1 - Hermetic 1 - Ermetico	
Defrost Sbrinamento	Manual Manuale	
Power supply Alimentazione	230 V / 1 Ph / 50 Hz	
Electrical input (nominal) Assorbimento elettrico (regime)	470 W / 3,8 A	930 W / 4,4 A
Electrical input (defrost) Assorbimento elettrico (sbrinamento)	-	-

Technical sheet about models whit condensing unit included with air cooled
Dati tecnici riferiti a modelli con unità a bordo con condensazione ad aria

Setup

Allestimento

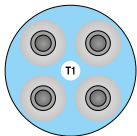
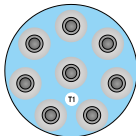
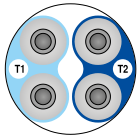
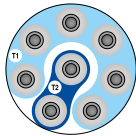
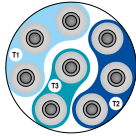
7 Lt ø 200x250H		4 (+4)	8 (+8)
T1			
T1 - T2			
T1 - T2 - T3		-	

4

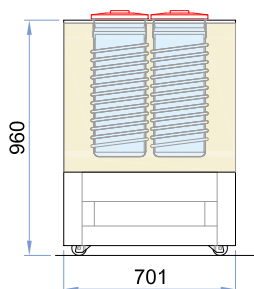

8

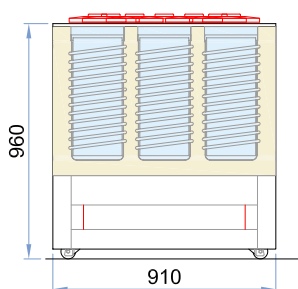

Metro ST

H 117 • 135

P 80

L 100 • 130

Pastry • Chocolate • Food & Beverage • Heated

	TN Chiller	TB Freezer	TB/TN Dual Temp
RS-Static			
RV-Ventilated	•		
TCS-Heated	•		
CH-Chocolate	•		

Installation

Plug-in

Configuration

- Glass shelves 2 (H117)
- Glass shelves 3 (H135)

Temperature

- -1/+5 °C (TN)
- +14/+16 °C (CH)
- +65 °C (TCS)

Refrigerant

R290

Refrigeration

Ventilated

Compressor

Hermetic

Defrost

Off cycle (TN-CH)

Climate class

3

Front glass

Double

Side glasses

Double

Rear closing system

Glass sliding doors

Opening system

Openable glass structure towards the bottom

Lightning

- 3000 K
- 4000 K (Optional)
- 5700 K (Optional)

Equipment handling

- Height adjustable feet
- Swivel casters with brake (Optional)

Color

White RAL 9003

Installazione

Plug-in

Configurazione

- Ripiani in vetro 2 (H117)
- Ripiani in vetro 3 (H135)

Temperatura

- -1/+5 °C (TN)
- +14/+16 °C (CH)
- +65 °C (TCS)

Refrigerante

R290

Refrigerazione

Ventilata (TN-CH)

Compressore

Ermetico

Sbrinamento

Fermata compressore (TN-CH)

Classe Climatica

3

Vetro frontale

Doppio (Camera)

Vetri laterali

Doppio (Camera)

Chiusura posteriore

Scorrevoli in vetro

Apertura anteriore

Apertura ribaltabile verso il basso

Illuminazione

- 3000 K
- 4000 K (Optional)
- 5700 K (Optional)

Movimentazione

- Piedini regolabili in altezza
- Ruote pivotanti con freno (Optional)

Colore

Bianco RAL 9003



R290

Metro ST

	100			130		
	RV TN	RV CH	TCS	RV TN	RV CH	TCS

External dimensions (LxDxH) Dimensioni esterne (LxPxH)	H117 H135	1000x833x1170/1216 mm 1000x833x1350/1397 mm			1300x833x1170/1216 mm 1300x833x1350/1397 mm		
Capacity (gross/net) Capacità (lorda/netta)	H117 H135	523,5 / 237,8 lt 652 / 305,6 lt			687 / 312,1 lt 855,5 / 401,2 lt		
Net weight Peso netto	H117 H135	200 kg 210 kg	175 kg 185 kg	205 kg 215 kg	180 kg 190 kg		
Refrigeration Refrigerazione		Ventilated Ventilata			Ventilated Ventilata		
Refrigerant Refrigerante		R290			R290		
Climate class Classe climatica		3					
Operating conditions Condizioni ambientali		25 °C / 60 %RH					
Product temperature Temperatura prodotto		-1/+5 °C	+14/+16 °C	+65 °C	-1/+5 °C	+14/+16 °C	+65 °C
Compressor (q.ty - type) Compressore (q.tà - tipologia)		1 - Hermetic 1 - Ermetico			1 - Hermetic 1 - Ermetico		
Defrost Sbrinamento		Off Cycle Fermata compressore			Off Cycle Fermata compressore		
Power supply Alimentazione		230 V / 1 Ph / 50 Hz					
Electrical input (nominal) Assorbimento elettrico (regime)		530 W / 3,1 A	750 W / 4,2 A	800 W / 3,5 A	550 W / 3,1 A	770 W / 4,3 A	930 W / 4,2 A
Electrical input (defrost) Assorbimento elettrico (sbrinamento)		35 W / 0,2 A			35 W / 0,2 A		

Technical sheet about models whit condensing unit included with air cooled
Dati tecnici riferiti a modelli con unità a bordo con condensazione ad aria

Setup

Allestimento

Shelf (LxD) Ripiano (LxP)	907 x 400 mm	1207 x 400 mm
Bottom shelf (LxD) Ripiano di fondo (LxP)	910 x 602 mm	1210 x 602 mm

H 117 | RV TN | RV CH

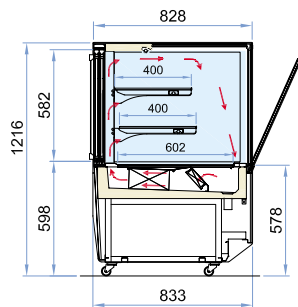
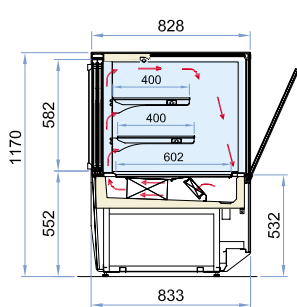

TCS

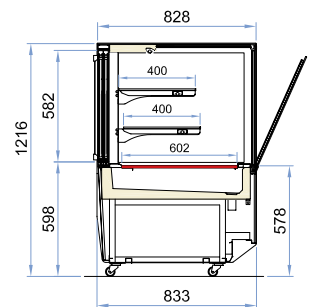
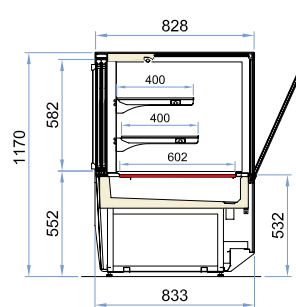

H 135 | RV TN | RV CH

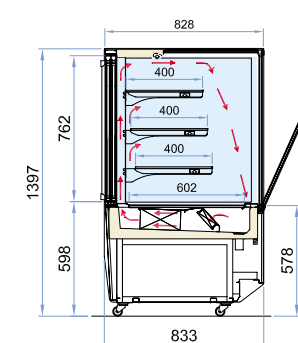
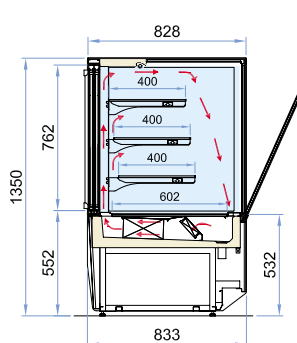

TCS

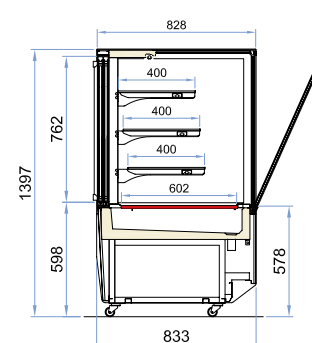
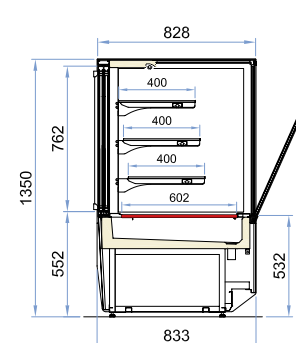

Metro ST Self

H 117 • 135

P 80

L 100 • 130

Pastry - Chocolate - Food & Beverage

	TN Chiller	TB Freezer	TB/TN Dual Temp
RS-Static			
RV-Ventilated	•		
TCS-Heated			
CH-Chocolate	•		

Installation

Plug-in

Configuration

- Glass shelves 2 (H117)
- Glass shelves 3 (H135)

Temperature

-1/+7 °C (TN - Self)

Refrigerant

R290

Refrigeration

Ventilated

Compressor

Hermetic

Defrost

Off cycle (TN)

Climate class

3

Side glasses

Double

Rear closing system

Glass sliding doors

Front closing system

Self rolling curtain

Lightning

- 3000 K
- 4000 K (Optional)
- 5700 K (Optional)

Equipment handling

- Height adjustable feet
- Swivel casters with brake (Optional)

Color

White RAL 9003

Installazione

Plug-in

Configurazione

- Ripiani in vetro 2 (H117)
- Ripiani in vetro 3 (H135)

Temperatura

-1/+7 °C (TN - Self)

Refrigerante

R290

Refrigerazione

Ventilata (TN)

Compressore

Ermetico

Sbrinamento

Fermata compressore (TN)

Classe Climatica

3

Vetri laterali

Doppio (Camera)

Chiusura posteriore

Scorrevoli in vetro

Chiusura anteriore

Tendina manuale autoavvolgente

Illuminazione

- 3000 K
- 4000 K (Optional)
- 5700 K (Optional)

Movimentazione

- Piedini regolabili in altezza
- Ruote pivotanti con freno (Optional)

Colore

Bianco RAL 9003



R290

Metro ST Self

	100	130
	RV TN	RV TN

External dimensions (LxDxH) Dimensioni esterne (LxPxH)	H117 H135	1000x833x1170/1216 mm 1000x833x1350/1397 mm	1300x833x1170/1216 mm 1300x833x1350/1397 mm
Capacity (gross/net) Capacità (lorda/netta)	H117 H135	105,8 / 410 lt 264,6 / 501,1 lt	258,1 / 538 lt 347,2 / 658 lt
Net weight Peso netto	H117 H135	200 kg 210 kg	205 kg 215 kg
Refrigeration Refrigerazione	Ventilated Ventilata		
Refrigerant Refrigerante	R290		
Climate class Classe climatica	3		
Operating conditions Condizioni ambientali	25 °C / 60 %RH		
Product temperature Temperatura prodotto	-1/+7 °C		
Compressor (q.ty - type) Compressore (q.tà - tipologia)	1 - Hermetic 1 - Ermetico		
Defrost Sbrinamento	Off Cycle Fermata compressore		
Power supply Alimentazione	230 V / 1 Ph / 50 Hz		
Electrical input (nominal) Assorbimento elettrico (regime)	850 W / 3,9 A	910 W / 4,1 A	
Electrical input (defrost) Assorbimento elettrico (sbrinamento)	60 W / 0,3 A		

Technical sheet about models whit condensing unit included with air cooled
Dati tecnici riferiti a modelli con unità a bordo con condensazione ad aria

Setup

Allestimento

Shelf (LxD) Ripiano (LxP)	907 x 260 mm 907 x 350 mm 907 x 400 mm	1207 x 260 mm 1207 x 350 mm 1207 x 400 mm
Bottom shelf (LxD) Ripiano di fondo (LxP)	910 x 602 mm	1210 x 602 mm

H 117 | RV TN

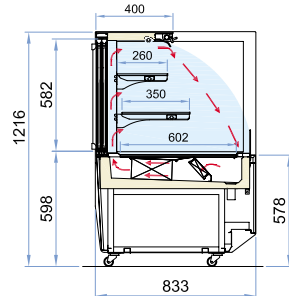
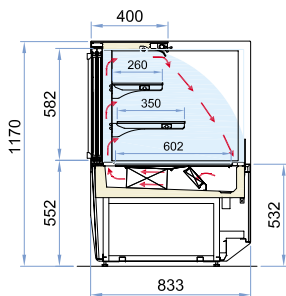

H 135 | RV TN

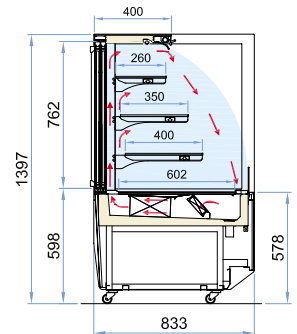
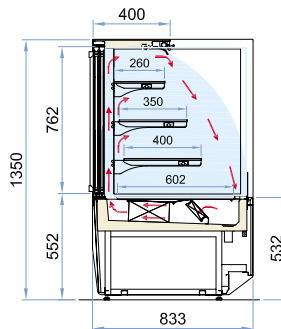

Maxi

H 64

P 95

L 154 • 204 • 256

Frozen Food

	TN Chiller	TB Freezer	TB/TN Dual Temp
RS-Static		•	
RV-Ventilated			
TCS-Heated			
CH-Chocolate			

Installation
Plug-in

Temperature
-18 °C

Refrigerant
R290

Refrigeration
Static

Compressor
Hermetic

Defrost
Manual

Climate class
4

Side panels/Structure
Insulated white
prepainted sheet

Opening system
Glass sliding lids

Equipment handling
Adjustable feet

Installazione
Plug-in

Temperatura
-18 °C

Refrigerante
R290

Refrigerazione
Statica

Compressore
Ermetico

Sbrinamento
Manuale

Classe climatica
4

Fianchi/Struttura
Coibentata lamiera
preverniciata bianca

Apertura
Scorrevoli in vetro

Movimentazione
Piedini regolabili in altezza

Internal color
Colore interno

White

Front color
Colore frontale

White

Sides color
Colore fianchi

White



R290

Maxi

	1500	2000	2500
External dimensions (LxDxH) Dimensioni esterne (LxPxH)	1540x955x780 mm	2040x955x780 mm	2557x955x780 mm
Capacity (gross/net) Capacità (lorda/netta)	589 / 442 Lt	834 / 632 Lt	1078 / 822 Lt
Net weight Peso netto	97 kg	120 kg	149 kg
Refrigeration Refrigerazione		Static Statica	
Refrigerant Refrigerante		R290	
Climate class Classe climatica		4	
Operating conditions Condizioni ambientali		30 °C / 55 %RH	
Product temperature Temperatura prodotto		-18 °C	
Compressor (type) Compressore (tipologia)		Hermetic - 1 Ermetico - 1	
Defrost Sbrinamento		Manual Manuale	
Power supply Alimentazione		230 V / 1 Ph / 50 Hz	
Electrical input (nominal) Assorbimento elettrico (regime)		570 W / 4,4 A	
Electrical input (defrost) Assorbimento elettrico (sbrinamento)		-	

Technical sheet about models whit condensing unit included with air cooled
Dati tecnici riferiti a modelli con unità a bordo con condensazione ad aria

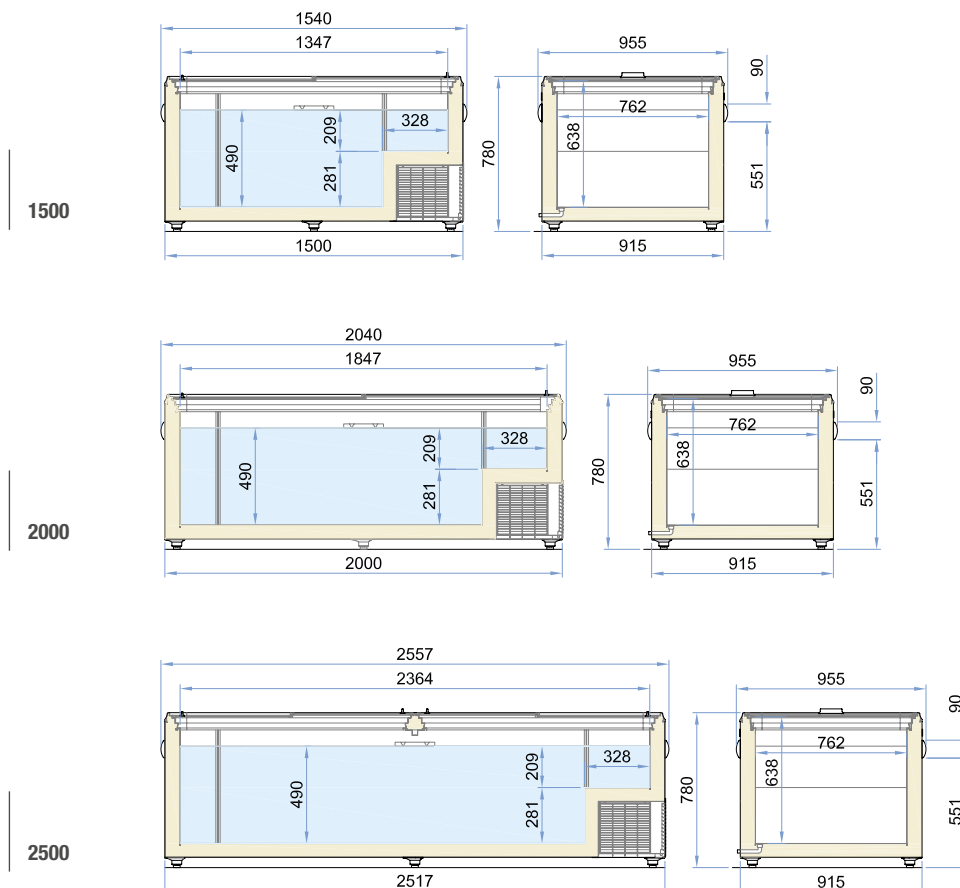

Galaxy TB

H 205

P 84

L 1P • 2P • 3P

Frozen Food

	TN Chiller	TB Freezer	TB/TN Dual Temp
RS-Static			
RV-Ventilated		•	
TCS-Heated			
CH-Chocolate			

Installation
Plug-in

Configuration
Shelves 5

Temperature
-18/-16 °C

Refrigerant
R290

Refrigeration
Ventilated

Compressor
Hermetic

Defrost
Hot gas

Climate class
3

Opening system
Self closing doors

Lighting
Led 5700 K

Equipment handling

- High adjustable feet
- Swivel casters with brake

Installazione
Plug-in

Configurazione
5 Mensole

Temperatura
-18/-16 °C

Refrigerante
R290

Refrigerazione
Ventilata

Compressore
Ermetico

Sbrinamento
Gas caldo

Classe climatica
3

Apertura
Porta con ritorno automatico

Illuminazione
Led 5700 K

Movimentazione

- Piedini regolabili in altezza
- Ruote pivotanti con freno

Internal color
Colore interno

- White (standard)
- Grey RAL 9006
- Black RAL 9005
- RAL on demand

External color
Colore esterno

- White (standard)
- Grey RAL 9006
- Black RAL 9005
- RAL on demand



R290

Galaxy TB

		1P	2P	3P
External dimensions (LxDxH) Dimensioni esterne (LxPxH)	Piedini	668x859x2048 mm	1340x859x2048 mm	2008x859x2048 mm
	Ruote	668x859x2141 mm	1340x859x2141 mm	2008x859x2141 mm
Capacity (gross/net) Capacità (lorda/netta)		526 / 350 Lt	1166 / 790 Lt	1807 / 1200 Lt
Net weight Peso netto		170 kg	310 kg	490 kg
Refrigeration Refrigerazione		Ventilated Ventilata		
Refrigerant Refrigerante		R290		
Climate class Classe climatica		3		
Operating conditions Condizioni ambientali		25 °C / 60 %RH		
Product temperature Temperatura prodotto		-18 / -16 °C		
Compressor (q.ty - type) Compressore (q.tà - tipologia)		1 - Hermetic 1 - Ermetico	2 - Hermetics 2 - Ermetico1	3 - Hermetics 3 - Ermetici
Defrost Sbrinamento		Hot gas Gas caldo		
Power supply Alimentazione		230 V / 1 Ph / 50 Hz		
Electrical input (nominal) Assorbimento elettrico (regime)		1000 W / 4,8 A	2000 W / 9,5 A	3000 W / 14,3 A
Electrical input (defrost) Assorbimento elettrico (sbrinamento)		1080 W / 4,6 A	2150 W / 9,2 A	3220 W / 13,8 A

Technical sheet about models whit condensing unit included with air cooled
Dati tecnici riferiti a modelli con unità a bordo con condensazione ad aria

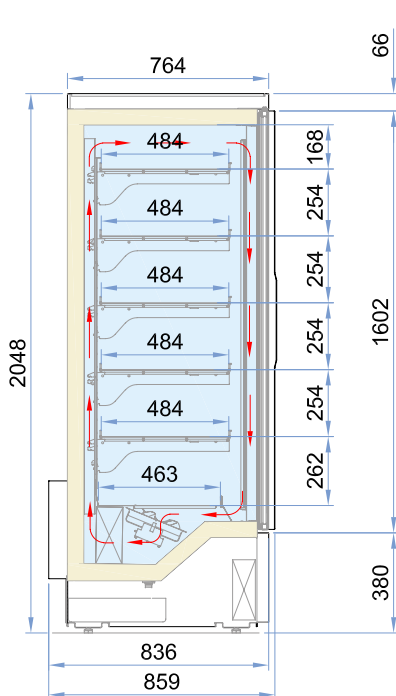

H205

Height adjustable feet
Piedini regolabili in altezza

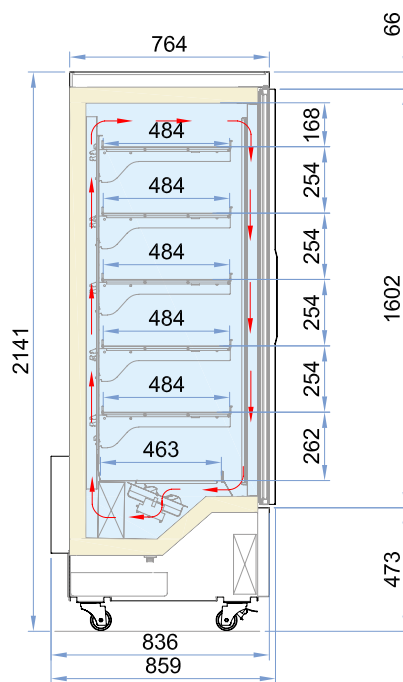

H205

Swivel casters with brake
Ruote pivotanti con freno

Maxivision

H 205

P 103

L 2P • 3P • 4P

Frozen Food

	TN Chiller	TB Freezer	TB/TN Dual Temp
RS-Static			
RV-Ventilated			•
TCS-Heated			
CH-Chocolate			

Installation

Remote unit

Temperature

- -18/-20 °C (TB)
- 0/+2 °C (TN)

Refrigerant

R452A

Refrigeration

Ventilated

Compressor

Remote condensing unit

Defrost

Electrical

Climate class

3

Front glass

Heated double glass

Side panels/Structure

Insulated white
prepainted sheet

Internal base

Stainless steel

Opening system

Glass door
with spring locking

Lighting

Neon

Shelves

10 (2P); 15 (3P); 20 (4P)

Equipment handling

Adjustable feet

Installazione

Remote unit

Temperatura

- -18/-20 °C (TB)
- 0/+2 °C (TN)

Refrigerante

R452A

Refrigerazione

Ventilata

Compressore

Unità condensatrice remota

Sbrinamento

Elettrico

Classe climatica

3

Vetro frontale

Vetro camera riscaldato

Fianchi/Struttura

Coibentati in lamiera
preverniciata bianca

Interno

Acciaio Inox finitura lucida

Apertura

Porte in vetro
con sistema di bloccaggio

Illuminazione

Neon + EC Fan motor

Ripiani

10 (2P); 15 (3P); 20 (4P)

Movimentazione

Piedini regolabili in altezza



Internal color

Colore interno

Inox

Front color

Colore frontale

Grigio

Sides color

Colore fianchi

White

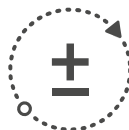

Dual
temperature

Maxivision		2P	3P	4P
External dimensions (LxDxH) Dimensioni esterne (LxPxH)		1750x1028x2050 mm	2550x1028x2050 mm	3360x1028x2050 mm
Capacity (gross/net) Capacità (lorda/netta)		1551 / 1428 Lt	2310 / 2127 Lt	3074 / 2830 Lt
Net weight Peso netto		332 kg	495 kg	652 kg
Refrigeration Refrigerazione		Ventilated Ventilata		
Refrigerant Refrigerante		R452A		
Climate class Classe climatica		3		
Operating conditions Condizioni ambientali		25 °C / 60 %RH		
Product temperature Temperatura prodotto		-18/ -20 °C		
		0/ +2 °C		
Compressor (type) Compressore (tipologia)		Remote condensing unit Unità condensatrice remota		
Defrost Sbrinamento		Electrical Elettrico		
Power supply Alimentazione		230 V / 1 Ph / 50 Hz		
Electrical input (nominal) Assorbimento elettrico (regime)		TB 650 W / 3,1 A	945 W / 4,6 A	1235 W / 5,9 A
		TN 420 W / 2 A	600 W / 2,9 A	775 W / 6,7 A
Electrical input (defrost) Assorbimento elettrico (sbrinamento)		TB 2600 W / 12,6 A	3400 W / 16,4 A	4480 W / 21,6 A
		TN 1365 W / 6,6 A	1555 W / 7,5 A	2020 W / 9,7 A

Technical sheet about models whit condensing unit included with air cooled
Dati tecnici riferiti a modelli con unità a bordo con condensazione ad aria

Accessorio

Item	2P	3P	4P
Grid with supports (806x500) Grid with supports (806x500)	8	12	16
Grid bottom (768x543) Griglia fondo vasca (768x543)	2	3	4

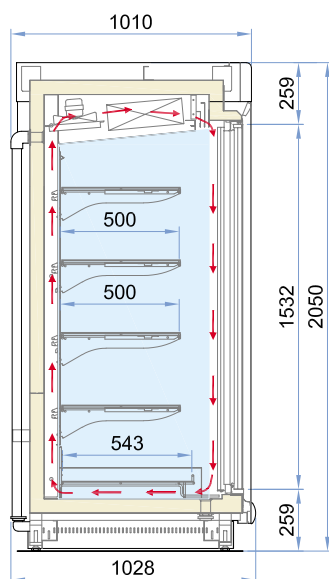

Marin TB

H 193

P 52 • 67

L 340 • 470

Frozen Food

	TN Chiller	TB Freezer	TB/TN Dual Temp
RS-Static		•	
RV-Ventilated		•	
TCS-Heated			
CH-Chocolate			

Installation

Plug-in

Temperature

- -18 °C (RS TB)
- -18 °C/-16 (RV TB)

Refrigerant

R290

Refrigeration

- Ventilated (RV TB)
- Static (RS TB)

Compressor

Hermetic

Defrost

- Manual (RS TB)
- Hot gas (RV TB)

Climate class

7

Front glass

Double glass

Side panels/Structure

Insulated white
pre-painted sheet

Internal base

White pre-painted sheet

Opening system

Self-closing swing open door

Lighting

Led 5700 K

Shelves

- 7+1 bottom (RS)
- 5+1 bottom (RV)

Equipment handling

Unidirectional runners
with adjustable feet

Installazione

Plug-in

Temperatura

- -18 °C (RS TB)
- -18 °C/-16 (RV TB)

Refrigerante

R290

Refrigerazione

- Ventilata (RV TB)
- Statica (RS TB)

Compressore

Ermetico

Sbrinamento

- Manuale (RS TB)
- Gas caldo (RV TB)

Classe climatica

7

Vetro frontale

Vetro camera

Fianchi/Struttura

Coibentati in lamiera
preverniciata bianca

Interno

Lamiera preverniciata bianca

Apertura

Porta a battente autochudente

Illuminazione

Led 5700 K

Ripiani

- 7+1 fondo vasca (RS)
- 5+1 fondo vasca (RV)

Movimentazione

Pattini unidirezionali
con piedini regolabili in altezza



Internal color

Colore interno

White

Front color

Colore frontale

White

Sides color

Colore fianchi

White



R290

470
RV

Marin TB

	340 RS	340 RV	470 RS	470 RV
External dimensions (LxDxH) Dimensioni esterne (LxPxH)	520x740x1935 mm	520x740x1935 mm	670x740x1935 mm	670x740x1935 mm
Capacity (gross/net) Capacità (lorda/netta)	353 / 296 Lt	353 / 230 Lt	485 / 385 Lt	485 / 315 Lt
Net weight Peso netto	108 kg	108 kg	128 kg	128 kg
Refrigeration Refrigerazione	Static Statica	Ventilated Ventilata	Static Statica	Ventilated Ventilata
Refrigerant Refrigerante	R290			
Climate class Classe climatica	7			
Operating conditions Condizioni ambientali	35 °C / 75 %RH			
Product temperature Temperatura prodotto	-18 °C	-18 / -16 °C	-18 °C	-18 / -16 °C
Compressor (type) Compressore (tipologia)	Hermetic - 1 Ermetico - 1			
Defrost Sbrinamento	Manual Manuale	Hot gas Gas caldo	Manual Manuale	Hot gas Gas caldo
Power supply Alimentazione	230 V / 1 Ph / 50 Hz			
Electrical input (nominal) Assorbimento elettrico (regime)	700 W / 4 A	750 W / 3,8 A	850 W / 4,7 A	750 W / 2,7 A
Electrical input (defrost) Assorbimento elettrico (sbrinamento)	-	1060 W / 4,9 A	-	1170 W / 4 A

Technical sheet about models whit condensing unit included with air cooled
Dati tecnici riferiti a modelli con unità a bordo con condensazione ad aria

Accessorio

Item	340 RS	340 RV	470 RS	470 RV
Grid with supports (380 x 470 mm) Griglia con supporti	-	•	-	-
Grid bottom (385 x 435 mm) Griglia fondo vasca	•	•	-	-
Grid with supports (530 x 470 mm) Griglia con supporti	-	-	-	•
Grid bottom (535 x 435 mm) Griglia fondo vasca	-	-	•	•



340
RS

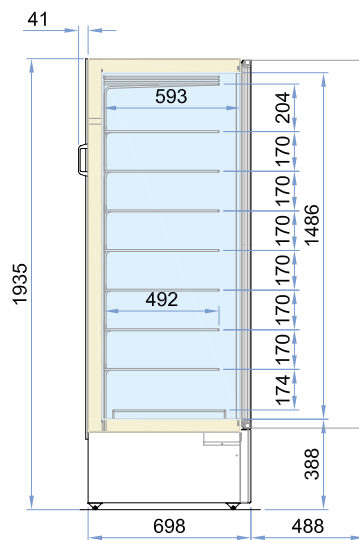

RS TB
Evaporating shelves fixed
Grid (optional) not available
Ripiani fissi evaporanti
Griglie (optional) non disponibili

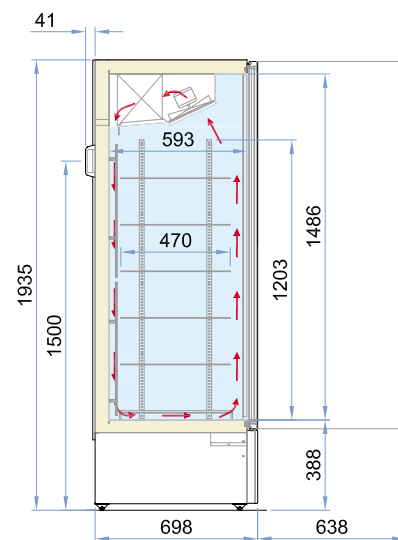

RV TB

Tornado TB

H 196

P 67 • 82

L 40 • 50

Frozen Food

	TN Chiller	TB Freezer	TB/TN Dual Temp
RS-Static		•	
RV-Ventilated		•	
TCS-Heated			
CH-Chocolate			

Installation

Plug-in

Temperature

- -18 °C (RS)
- -18 °C/-16 (RV)

Refrigerant

R290 (RV)

Refrigeration

- Static (RS)
- Ventilated (RV)

Compressor

Hermetic

Defrost

- Manual (RS TB)
- Hot gas (RV TB)

Climate class

4

Front glass

Heated double glass

Side panels/Structure

Insulated white
pre-painted sheet

Internal base

White pre-painted sheet

Opening system

Self-closing swing open door

Lighting

Led 5700 K

Shelves

- 6 (RS)
- 5 (RV)

Equipment handling

Unidirectional runners
with adjustable feet

Internal color

Colore interno

White

Front color

Colore frontale

White

Installazione

Plug-in

Temperatura

- -18 °C (RS)
- -18 °C/-16 (RV)

Refrigerante

R290 (RV)

Refrigerazione

- Statica (RS)
- Ventilata (RV)

Compressore

Ermetico

Sbrinamento

- Manuale (RS)
- Gas caldo (RV)

Classe climatica

4

Vetro frontale

Vetro camera riscaldato

Fianchi/Struttura

Coibentati in lamiera
preverniciata bianca

Interno

Lamiera preverniciata bianca

Apertura

Porta a battente autochudente

Illuminazione

Led 5700 K

Ripiani

- 6 (RS)
- 5 (RV)

Movimentazione

Pattini unidirezionali
con piedini regolabili in altezza

Sides color

Colore fianchi

White



R290

Tornado TB

	40 RS	40 RV	50 RV
External dimensions (LxDxH) Dimensioni esterne (LxPxH)	670x675x1960 mm	670x675x1960 mm	670x825x1960 mm
Capacity (gross/net) Capacità (lorda/netta)	400 / 285 Lt	400 / 265 Lt	530 / 335 Lt
Net weight Peso netto	126 kg		151 kg
Refrigeration Refrigerazione	Static Statica	Ventilated Ventilata	
Refrigerant Refrigerante	R290		
Climate class Classe climatica	4		
Operating conditions Condizioni ambientali	30 °C / 55 %RH		
Product temperature Temperatura prodotto	-18 °C	-18 / -16 °C	
Compressor (type) Compressore (tipologia)	Hermetic - 1 Ermetico - 1		
Defrost Sbrinamento	Manual Manuale	Hot gas Gas caldo	
Power supply Alimentazione	230 V / 1 Ph / 50 Hz		
Electrical input (nominal) Assorbimento elettrico (regime)	700 W / 4,5 A	530 W / 3,8 A	750 W / 2,7 A
Electrical input (defrost) Assorbimento elettrico (sbrinamento)	-	840 W / 4,8 A	1170 W / 4 A

Technical sheet about models whit condensing unit included with air cooled
Dati tecnici riferiti a modelli con unità a bordo con condensazione ad aria

Accessorio

Item	40 RS	40 RV	50 RV
Grid (532 x 410 mm) Griglia	5	5	-
Grid (532 x 505 mm) Griglia	-	-	5

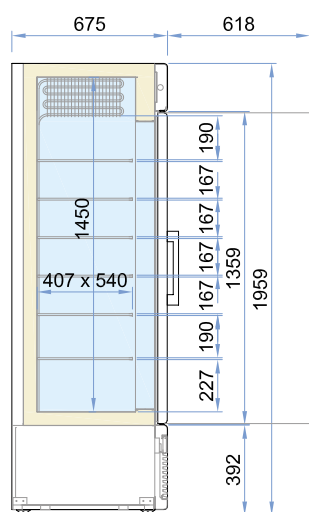

40 RS TB

Evaporating shelves fixed

Grid (optional) not available

Ripiani fissi evaporanti

Griglie (optional) non disponibili

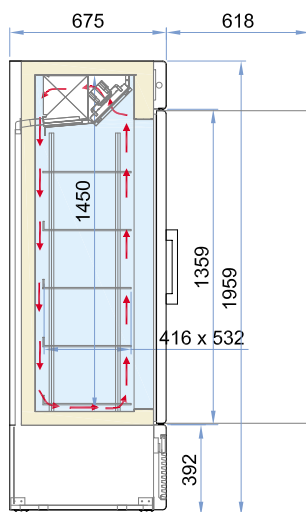

40 RV TB

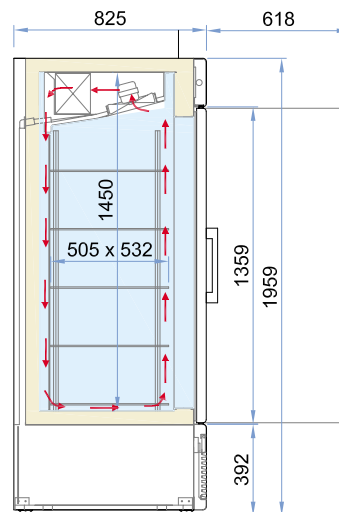

50 RV TB

Tornado TN

H 196

P 67 • 82

L 40 • 50

Food & Beverage

	TN Chiller	TB Freezer	TB/TN Dual Temp
RS-Static	•		
RV-Ventilated	•		
TCS-Heated			
CH-Chocolate			

Installation

Plug-in

Temperature

-1 / +5 °C

Refrigerant

R290

Refrigeration

- Static (RS)
- Ventilated (RV)

Compressor

Hermetic

Defrost

Off cycle

Climate class

4

Front glass

Heated double glass

Side panels/Structure

Insulated white
prepainted sheet

Internal base

White prepainted sheet

Opening system

Self-closing swing open door

Lighting

Led 5700 K

Shelves

5

Equipment handling

Unidirectional runners
with adjustable feet

Internal color

Colore interno

White

Front color

Colore frontale

White

Installazione

Plug-in

Temperatura

-1 / +5 °C

Refrigerante

R290

Refrigerazione

- Statica (RS)
- Ventilata (RV)

Compressore

Ermetico

Sbrinamento

Fermata compressore

Classe climatica

4

Vetro frontale

Vetro camera riscaldato

Fianchi/Struttura

Coibentati in lamiera
preverniciata bianca

Interno

Lamiera preverniciata bianca

Apertura

Porta a battente autochiudente

Illuminazione

Led 5700 K

Ripiani

5

Movimentazione

Pattini unidirezionali
con piedini regolabili in altezza

Sides color

Colore fianchi

White



R290

Tornado TN

	40 RS	40 RV	50 RV
External dimensions (LxDxH) Dimensioni esterne (LxPxH)	670x675x1960 mm	670x675x1960 mm	670x825x1960 mm
Capacity (gross/net) Capacità (lorda/netta)	400 / 265 Lt	400 / 260 Lt	530 / 335 Lt
Net weight Peso netto	126 kg		151 kg
Refrigeration Refrigerazione	Static Statica	Ventilated Ventilata	
Refrigerant Refrigerante	R290		
Climate class Classe climatica	4		
Operating conditions Condizioni ambientali	30 °C / 55 %RH		
Product temperature Temperatura prodotto	-1 / +5 °C		
Compressor (type) Compressore (tipologia)	Hermetic - 1 Ermetico - 1		
Defrost Sbrinamento	Off cycle Fermata compressore		
Power supply Alimentazione	230 V / 1 Ph / 50 Hz		
Electrical input (nominal) Assorbimento elettrico (regime)	400 W / 2,2 A	430 W / 2,3 A	520 W / 2,8 A
Electrical input (defrost) Assorbimento elettrico (sbrinamento)	120 W / 0,7 A	110 W / 0,7 A	140 W / 0,8 A

Technical sheet about models whit condensing unit included with air cooled
Dati tecnici riferiti a modelli con unità a bordo con condensazione ad aria

Accessorio

Item	40 RS	40 RV	50 RV
Grid (532 x 410 mm) Griglia	5	5	-
Grid (532 x 505 mm) Griglia	-	-	5

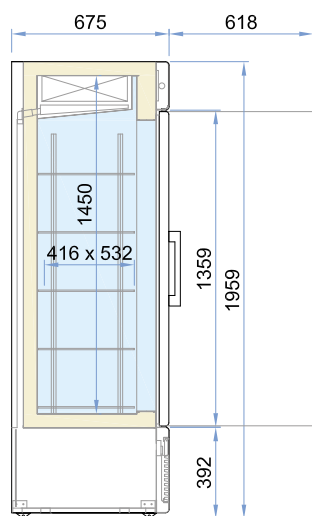

40 RS TN

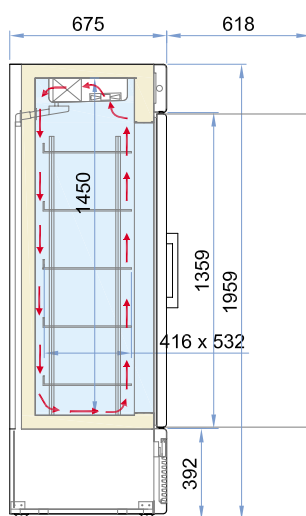

40 RV TN

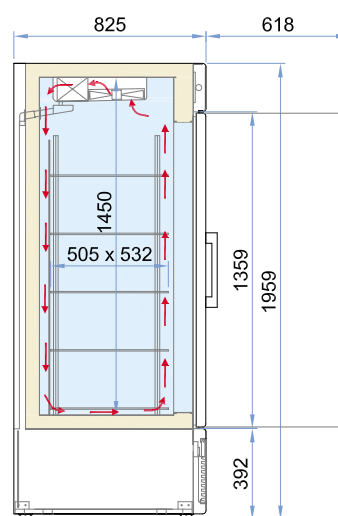

50 RV TN

Tornado 100 TN-TB

H 193

P 52 • 67

L 100

Frozen Food - Food & Beverage

	TN Chiller	TB Freezer	TB/TN Dual Temp
RS-Static			
RV-Ventilated			•
TCS-Heated			
CH-Chocolate			

Installation

Plug-in

Temperature

- -18 / -16 °C (TB-TN / TB-TB)
- -1 / +5 °C (TN / TB-TN)

Refrigerant

R290

Refrigeration

Ventilated

Compressor

Hermetic

Defrost

- Hot gas (TB)
- Off cycle (TN)

Climate class

4

Front glass

Heated double glass

Side panels/Structure

Insulated white
prepainted sheet

Internal base

White prepainted sheet

Opening system

Self-closing swing open door

Lighting

Led 5700 K

Shelves

5 - 10

Equipment handling

Unidirectional runners
with adjustable feet

Installazione

Plug-in

Temperatura

- -18 / -16 °C (TB-TN / TB-TB)
- -1 / +5 °C (TN / TB-TN)

Refrigerante

R290

Refrigerazione

Ventilata

Compressore

Ermetico

Sbrinamento

- Gas caldo (TB)
- Fermata compressore (TN)

Classe climatica

4

Vetro frontale

Vetro camera riscaldato

Fianchi/Struttura

Coibentati in lamiera
preverniciata bianca

Interno

Lamiera preverniciata bianca

Apertura

Porta a battente autochiudente

Illuminazione

Led 5700 K

Ripiani

5 - 10

Movimentazione

Pattini unidirezionali
con piedini regolabili in altezza

Internal color

Colore interno

White

Front color

Colore frontale

White

Sides color

Colore fianchi

White



R290



Dual
temperature

Tornado 100 TN-TB

	TB-TN	TN-TN	TB-TB
External dimensions (LxDxH) Dimensioni esterne (LxPxH)	1340x825x1960 mm	1340x825x1960 mm	1340x825x1960 mm
Capacity (gross/net) Capacità (lorda/netta)	1060 / 670 Lt		
Net weight Peso netto	295 kg		
Refrigeration Refrigerazione	Ventilated Ventilata		
Refrigerant Refrigerante	R290		
Climate class Classe climatica	4		
Operating conditions Condizioni ambientali	30 °C / 55 %RH		
Product temperature Temperatura prodotto	-18 / -16 °C (TB) -1 / +5 °C (TN)	-1 / +5 °C	-18 / -16 °C
Compressor (type) Compressore (tipologia)	Hermetic - 2 Ermetico - 2		
Defrost Sbrinamento	Hot gas (TB) / Off cycle (TN) Gas caldo (TB) / Ferm. compr. (TN)	Off cycle Fermata compressore	Hot gas Gas caldo
Power supply Alimentazione	230 V / 1 Ph / 50 Hz		
Electrical input (nominal) Assorbimento elettrico (regime)	1650 W / 8,9 A	750 W / 4,1 A	1740 W / 8,6 A
Electrical input (defrost) Assorbimento elettrico (sbrinamento)	1800 W / 11,8 A	160 W / 1 A	2840 W / 13,4 A

Technical sheet about models whit condensing unit included with air cooled
Dati tecnici riferiti a modelli con unità a bordo con condensazione ad aria

Accessorio

Item

Grid (532 x 505 mm) Griglia	5+5	5+5	5+5
---------------------------------------	-----	-----	-----

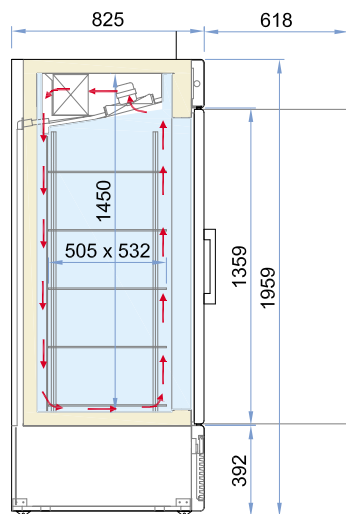
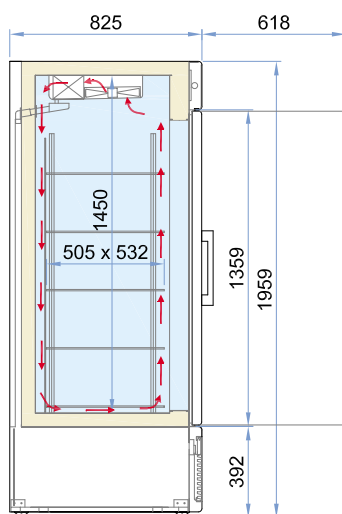
100 RV TB

100 RV TN

Mistral TB

H 196

P 73 • 88

L 40 • 50

Frozen Food

	TN Chiller	TB Freezer	TB/TN Dual Temp
RS-Static		•	
RV-Ventilated		•	
TCS-Heated			
CH-Chocolate			

Installation

Plug-in

Temperature

- -18 °C (RS)
- -18 / -16 °C (RV)

Refrigerant

R290

Refrigeration

- Static (RS)
- Ventilated (RV)

Compressor

Hermetic

Defrost

- Off cycle
- Hot gas

Climate class

4

Front glass

Curved heated double glass

Side panels/Structure

Rounded insulated white prepainted sheet

Internal base

White prepainted sheet

Opening system

Self-closing swing open door

Lighting

Led 5700 K

Shelves

5

Equipment handling

Unidirectional runners with adjustable feet

Installazione

Plug-in

Temperatura

- -18 °C (RS)
- -18 / -16 °C (RV)

Refrigerante

R290

Refrigerazione

- Statica (RS)
- Ventilata (RV)

Compressore

Ermetico

Sbrinamento

- Manuale
- Gas caldo

Classe climatica

4

Vetro frontale

Vetro curvo panoramico a camera riscaldato

Fianchi/Struttura

Coibentati arrotondati in lamiera preverniciata bianca

Interno

Lamiera preverniciata bianca

Apertura

Porta a battente autochiudente

Illuminazione

Led 5700 K

Ripiani

5

Movimentazione

Pattini unidirezionali con piedini regolabili in altezza



Internal color

Colore interno

White

Front color

Colore frontale

White

Sides color

Colore fianchi

White



R290

Mistral TB

	40 RS	50 RV
External dimensions (LxDxH) Dimensioni esterne (LxPxH)	670x735x1960 mm	670x885x1960 mm
Capacity (gross/net) Capacità (lorda/netta)	400 / 285 Lt	530 / 335 Lt
Net weight Peso netto	126 kg	151 kg
Refrigeration Refrigerazione	Static Statica	Ventilated Ventilata
Refrigerant Refrigerante	R290	
Climate class Classe climatica	4	
Operating conditions Condizioni ambientali	30 °C / 55 %RH	
Product temperature Temperatura prodotto	-18 °C	-18 / -16 °C
Compressor (type) Compressore (tipologia)	Hermetic - 1 Ermetico - 1	
Defrost Sbrinamento	Manual Manuale	Hot gas Gas caldo
Power supply Alimentazione	230 V / 1 Ph / 50 Hz	
Electrical input (nominal) Assorbimento elettrico (regime)	700 W / 4,5 A	750 W / 2,7 A
Electrical input (defrost) Assorbimento elettrico (sbrinamento)	-	1170 W / 4 A

Technical sheet about models with condensing unit included with air cooled
Dati tecnici riferiti a modelli con unità a bordo con condensazione ad aria

Accessorio

Item

Grid (532 x 505 mm) Griglia	-	5
---------------------------------------	---	---

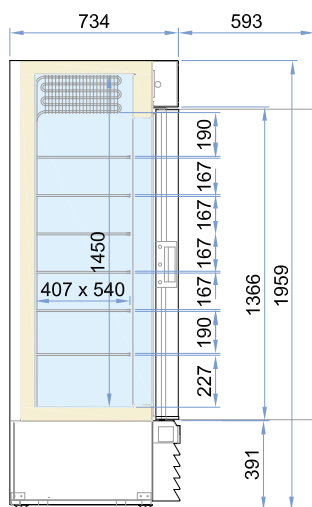

40 RS TB

Evaporating shelves fixed

Grid (optional) not available

Ripiani fissi evaporanti

Griglie (optional) non disponibili

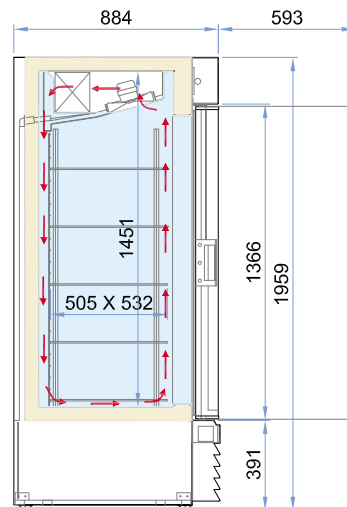

50 RV TB

Mistral TN

H 196

P 73 • 88

L 40 • 50

Food & Beverage

	TN Chiller	TB Freezer	TB/TN Dual Temp
RS-Static	•		
RV-Ventilated	•		
TCS-Heated			
CH-Chocolate			

Installation

Plug-in

Temperature

-1 / +5°C

Refrigerant

R290

Refrigeration

- Static (RS)
- Ventilated (RV)

Compressor

Hermetic

Defrost

Off cycle

Climate class

4

Front glass

Curved heated
double glass

Side panels/Structure

Rounded insulated
white prepainted sheet

Internal base

White prepainted sheet

Opening system

Self-closing swing open door

Lighting

Led 5700 K

Shelves

5

Equipment handling

Unidirectional runners
with adjustable feet

Installazione

Plug-in

Temperatura

-1 / +5°C

Refrigerante

R290

Refrigerazione

- Statica (RS)
- Ventilata (RV)

Compressore

Ermetico

Sbrinamento

Fermata compressore

Classe climatica

4

Vetro frontale

Vetro curvo panoramico
a camera riscaldato

Fianchi/Struttura

Coibentati arrotondati
in lamiera preverniciata bianca

Interno

Lamiera preverniciata bianca

Apertura

Porta a battente autochiudente

Illuminazione

Led 5700 K

Ripiani

5

Movimentazione

Pattini unidirezionali
con piedini regolabili in altezza

Internal color

Colore interno

White

Front color

Colore frontale

White

Sides color

Colore fianchi

White



R290

Mistral TN

	40 RS	40 RV	50 RV
External dimensions (LxDxH) Dimensioni esterne (LxPxH)	670x735x1960 mm	670x735x1960 mm	670x885x1960 mm
Capacity (gross/net) Capacità (lorda/netta)	400 / 265 Lt	400 / 260 Lt	530 / 335 Lt
Net weight Peso netto	126 kg		151 kg
Refrigeration Refrigerazione	Static Statica	Ventilated Ventilata	
Refrigerant Refrigerante	R290		
Climate class Classe climatica	4		
Operating conditions Condizioni ambientali	30 °C / 55 %RH		
Product temperature Temperatura prodotto	-1 / +5 °C		
Compressor (type) Compressore (tipologia)	Hermetic - 1 Ermetico - 1		
Defrost Sbrinamento	Off cycle Fermata compressore		
Power supply Alimentazione	230 V / 1 Ph / 50 Hz		
Electrical input (nominal) Assorbimento elettrico (regime)	400 W / 2,2 A	430 W / 2,3 A	520 W / 2,8 A
Electrical input (defrost) Assorbimento elettrico (sbrinamento)	120 W / 0,7 A	110 W / 0,7 A	140 W / 0,8 A

Technical sheet about models whit condensing unit included with air cooled
Dati tecnici riferiti a modelli con unità a bordo con condensazione ad aria

Accessorio

Item

Grid (532 x 410 mm) Griglia	5	5	-
Grid (532 x 505 mm) Griglia	-	-	5

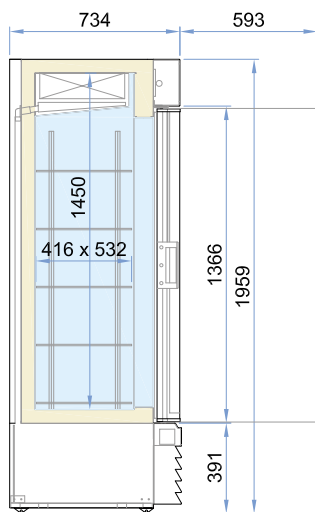
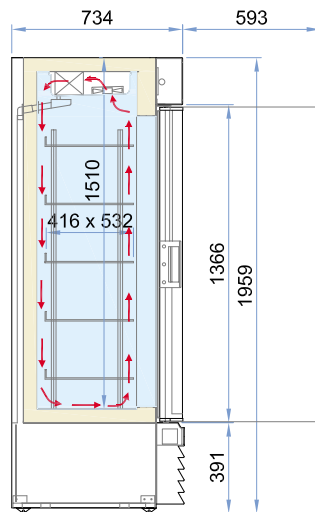
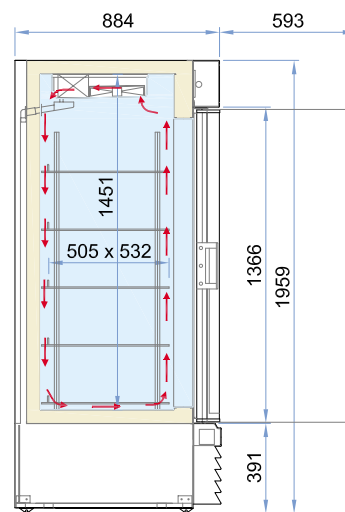
40 RS TN

40 RV TN

50 RV TN

Sky

H 182

P 60

L 59

Food & Beverage

	TN Chiller	TB Freezer	TB/TN Dual Temp
RS-Static			
RV-Ventilated	•		
TCS-Heated			
CH-Chocolate			

Installation

Plug-in

Temperature

-1 / +7°C

Refrigerant

R134a

Refrigeration

Ventilated

Compressor

Hermetic

Defrost

Off cycle

Climate class

4

Front glass

Double glass

Side panels/Structure

Rounded insulated
white prepainted sheet

Internal base

White prepainted sheet

Opening system

Self-closing swing open door

Lighting

Led 5700 K

Shelves

4

Equipment handling

Unidirectional runners
with adjustable feet

Installazione

Plug-in

Temperatura

-1 / +7°C

Refrigerante

R134a

Refrigerazione

Ventilata

Compressore

Ermetico

Sbrinamento

Fermata compressore

Classe climatica

4

Vetro frontale

Vetro camera

Fianchi/Struttura

Coibentati in lamiera
preverniciata bianca

Interno

Lamiera preverniciata bianca

Apertura

Porta a battente autochiudente

Illuminazione

Led 5700 K

Ripiani

4

Movimentazione

Pattini unidirezionali
con piedini regolabili in altezza

Internal color

Colore interno

White

Front color

Colore frontale

White

Black

Sides color

Colore fianchi

White

Black



White

N.B. The standard version features 4 grid shelves

La versione di serie prevede 4 griglie

Sky

External dimensions (LxDxH) Dimensioni esterne (LxPxH)	595x597x1825 mm	
Capacity (gross/net) Capacità (lorda/netta)	365 / 310 Lt	
Net weight Peso netto	85 kg	
Refrigeration Refrigerazione	Ventilated Ventilata	
Refrigerant Refrigerante	R134a	
Climate class Classe climatica	4	
Operating conditions Condizioni ambientali	30 °C / 55 %RH	
Product temperature Temperatura prodotto	-1 / +7 °C	
Compressor (type) Compressore (tipologia)	Hermetic - 1 Ermetico - 1	
Defrost Sbrinamento	Off cycle Fermata compressore	
Power supply Alimentazione	230 V / 1 Ph / 50 Hz	
Electrical input (nominal) Assorbimento elettrico (regime)	330 W / 2,5 A	450 W / 2,1 A
Electrical input (defrost) Assorbimento elettrico (sbrinamento)	50 W / 0,6 A	10 W / 0,1 A

Technical sheet about models whit condensing unit included with air cooled
Dati tecnici riferiti a modelli con unità a bordo con condensazione ad aria

Accessorio

Item	
Grid (500 x 410 mm) Griglia	5
Price holder Portaprezzi	•

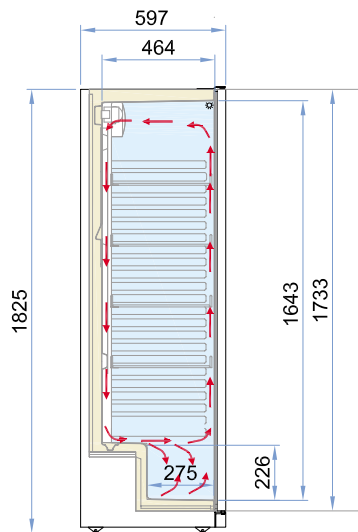

Black

Barrique

H 182

P 60

L 59

Food & Beverage

	TN Chiller	TB Freezer	TB/TN Dual Temp
RS-Static			
RV-Ventilated	•		
TCS-Heated			
CH-Chocolate			

Installation

Plug-in

Temperature

+5/ +15 °C

Refrigerant

R134a

Refrigeration

Ventilated

Compressor

Hermetic

Defrost

Off cycle

Climate class

4

Front glass

Double glass

Side panels/Structure

Rounded insulated
white prepainted sheet

Internal base

White prepainted sheet

Opening system

Self-closing swing open door

Lighting

Led 5700 K

Shelves

4

Equipment handling

Unidirectional runners
with adjustable feet

Internal color

Colore interno

White

Front color

Colore frontale

Black

Installazione

Plug-in

Temperatura

+5/ +15 °C

Refrigerante

R134a

Refrigerazione

Ventilata

Compressore

Ermetico

Sbrinamento

Fermata compressore

Classe climatica

4

Vetro frontale

Vetro camera

Fianchi/Struttura

Coibentati in lamiera
preverniciata bianca

Interno

Lamiera preverniciata bianca

Apertura

Porta a battente autochiudente

Illuminazione

Led 5700 K

Ripiani

4

Movimentazione

Pattini unidirezionali
con piedini regolabili in altezza

Sides color

Colore fianchi

Black



N.B. The standard version features 4 grid shelves
La versione di serie prevede 4 griglie

Barrique

External dimensions (LxDxH) Dimensioni esterne (LxPxH)	595x597x1825 mm
Capacity (gross/net) Capacità (lorda/netta)	365 / 310 Lt
Net weight Peso netto	85 kg
Refrigeration Refrigerazione	Ventilated Ventilata
Refrigerant Refrigerante	R134a
Climate class Classe climatica	4
Operating conditions Condizioni ambientali	30 °C / 55 %RH
Product temperature Temperatura prodotto	+5 / +15 °C
Compressor (type) Compressore (tipologia)	Hermetic - 1 Ermetico - 1
Defrost Sbrinamento	Off cycle Fermata compressore
Power supply Alimentazione	230 V / 1 Ph / 50 Hz
Electrical input (nominal) Assorbimento elettrico (regime)	330 W / 2,5 A
Electrical input (defrost) Assorbimento elettrico (sbrinamento)	50 W / 0,6 A

Technical sheet about models whit condensing unit included with air cooled
Dati tecnici riferiti a modelli con unità a bordo con condensazione ad aria

Accessorio

Item	
Grid (500 x 410 mm) Griglia	5
Price holder Portaprezzi	•

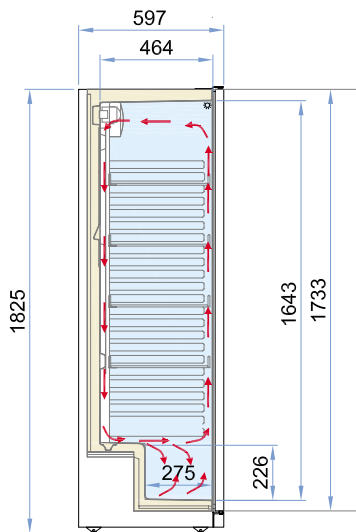

Action

H 87
P 90
L 110 • 140

Frozen Food - Food & Beverage

	TN Chiller	TB Freezer	TB/TN Dual Temp
RS-Static			
RV-Ventilated			•
TCS-Heated			
CH-Chocolate			

Installation

Plug-in

Temperature
• -18 / -16 °C (TB)
• -1 / +5 °C (TN)

Refrigerant
R290

Refrigeration
Ventilated

Compressor
Hermetic

Defrost
Hot gas

Climate class
4

Front glass
Heated (double)

Side glass
Heated (double)

Closing system
Sliding glass

Lighting
Led 5700 K

Equipment handling
Unidirectional runners

Installazione
Plug-in

Temperatura
• -18 / -16 °C (TB)
• -1 / +5 °C (TN)

Refrigerante
R290

Refrigerazione
Ventilata

Compressore
Ermetico

Sbrinamento
Gas caldo

Classe climatica
4

Vetro frontale
Doppio (camera) riscaldato

Vetri laterali
Doppio (camera) riscaldato

Chiusura
Scorrevoli in vetro

Illuminazione
Led 5700 K

Movimentazione
Pattini unidirezionali

Internal color
Colore interno

Gray

Front color
Colore frontale

Gray

Sides color
Colore fianchi

Gray



R290



Dual
temperature

Action	70	100
External dimensions (LxDxH) Dimensioni esterne (LxPxH)	760 x 820 x 870 mm	1060 x 820 x 870 mm
Capacity (gross/net) Capacità (lorda/netta)	160/82 lt	238/126 lt
Net weight Peso netto	118 kg	130 kg
Refrigeration Refrigerazione	Ventilated - Ventilata	
Refrigerant Refrigerante	R290	
Climatic class Classe climatica	4	
Operating conditions Condizioni ambientali	30 °C / 55 %RH	
Product temperature Temperatura prodotto	TB	-18/ -16 °C
	TN	-1/ +5 °C
Compressor (q.ty-type) Compressore (q.tà-tipologia)	1 Hermetic - 1 Ermetico	
Defrost Sbrinamento	Hot gas - Gas caldo	
Power supply Alimentazione	230 V / 1 Ph / 50 Hz	
Electrical input (standard) Assorbimento elettrico (standard)	620 W / 4 A	1000 W / 4,8 A
Electrical input (defrost) Assorbimento elettrico (sbrinamento)	760 W / 4,5 A	1400 W / 6 A

Technical sheet about models whit condensing unit included with air cooled
Dati tecnici riferiti a modelli con unità a bordo con condensazione ad aria

Expo

H 87
P 75
L 56

Frozen Food - Food & Beverage

	TN Chiller	TB Freezer	TB/TN Dual Temp
RS-Static			
RV-Ventilated			•
TCS-Heated			
CH-Chocolate			

Installation

Plug-in

Temperature
• -18 / -16 °C (TB)
• -1 / +5 °C (TN)

Refrigerant
R290

Refrigeration
Ventilated

Compressor
Hermetic

Defrost
Hot gas

Climate class
4

Front glass
Heated (double)

Side glass
Heated (double)

Closing system
Sliding glass

Lighting
Led 5700 K

Equipment handling
Unidirectional runners

Installazione
Plug-in

Temperatura
• -18 / -16 °C (TB)
• -1 / +5 °C (TN)

Refrigerante
R290

Refrigerazione
Ventilata

Compressore
Ermetico

Sbrinamento
Gas caldo

Classe climatica
4

Vetro frontale
Doppio (camera) riscaldato

Vetri laterali
Doppio (camera) riscaldato

Chiusura
Scorrevoli in vetro

Illuminazione
Led 5700 K

Movimentazione
Pattini unidirezionali

Internal color
Colore interno

Gray

Front color
Colore frontale

Gray

Sides color
Colore fianchi

Gray



R290



Dual
temperature

External dimensions (LxDxH) Dimensioni esterne (LxPxH)	560 x 750 x 870 mm	
Capacity (gross/net) Capacità (lorda/netta)	143/86 lt	
Net weight Peso netto	81 kg	
Refrigeration Refrigerazione	Ventilated - Ventilata	
Refrigerant Refrigerante	R290	
Climatic class Classe climatica	4	
Operating conditions Condizioni ambientali	30 °C / 55 %RH	
Product temperature Temperatura prodotto	TB	-18/ -16 °C
	TN	-1/ +5 °C
Compressor (q.ty-type) Compressore (q.tà-tipologia)	1 Hermetic - 1 Ermetico	
Defrost Sbrinamento	Hot gas - Gas caldo	
Power supply Alimentazione	230 V / 1 Ph / 50 Hz	
Electrical input (standard) Assorbimento elettrico (standard)	400 W / 2,1 A	
Electrical input (defrost) Assorbimento elettrico (sbrinamento)	810 W / 3,9 A	

Technical sheet about models whit condensing unit included with air cooled
Dati tecnici riferiti a modelli con unità a bordo con condensazione ad aria



ISA was founded in Umbria in 1963, in the heart of Italy, renowned worldwide for its artisan, industrial, and creative excellence. Thanks to the new highly technological and efficient factory, and the presence in more over 110 countries, ISA is one of the most important players in the production of refrigerated display units and furniture for the ice-cream industry, pastry, food service, and organized distribution all over the world.

ISA nasce in Umbria nel 1963, nel cuore di quell'Italia rinomata in tutto il mondo per la sua eccellenza artigiana, industriale e creativa. Grazie al nuovo stabilimento, dotato delle più avanzate tecnologie, e alla presenza in oltre 110 paesi, ISA è uno dei player più importanti al mondo nella produzione di espositori refrigerati e arredamento per gelateria, pasticceria, ristorazione e distribuzione organizzata.



In the interest of continual product improvements, ISA S.p.A. reserves the right to make changes in technical specifications and accessories at any moment and without prior notice.

La ISA S.p.A. nell'ambito del continuo miglioramento del prodotto, si riserva il diritto di modificare in qualsiasi momento, senza preavviso, le caratteristiche tecniche ed estetiche dei propri modelli.



ISA S.p.A.

via Madonna di Campagna 123
06083 Bastia Umbra (PG)
Italy

T. +39 075 801 71

F. +39 075 800 09 00

E. customerservice@isaitaly.com

www.isaitaly.com

