

# Masszeichnung Einbaukühlwanne UKW 3/1-Z

[Art. 484253811]

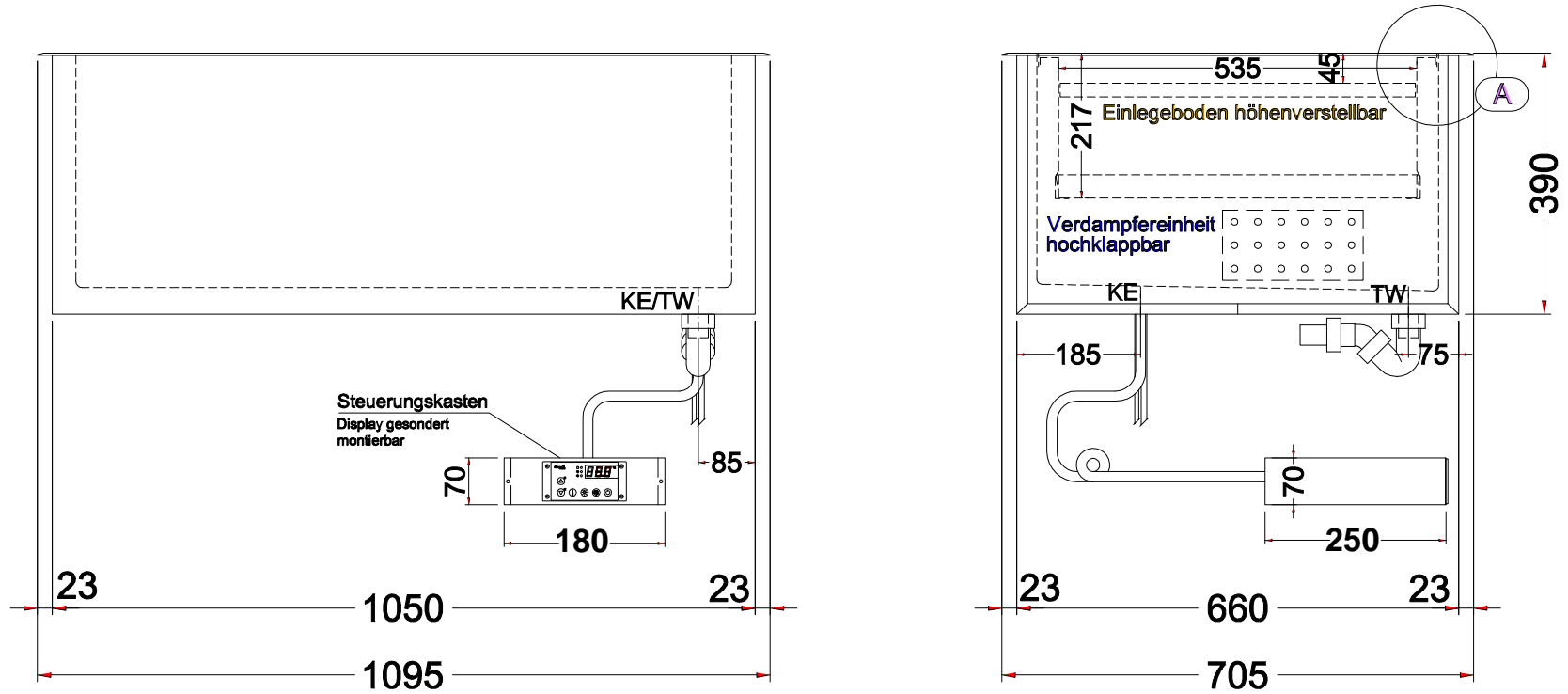

TW = Tauwasserablauf DNØ30  
KE = Kälte-Elektro

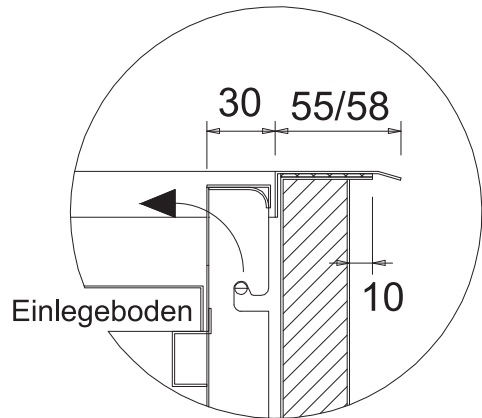

Detail A:

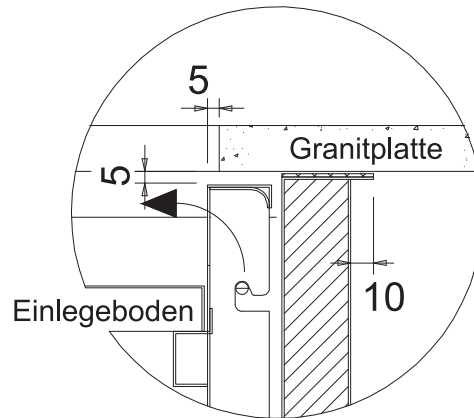

Detail A: Granitunterbau

