

Masszeichnung Einbaukühlwanne UKW 1/1-Z

[Art. 484253791]

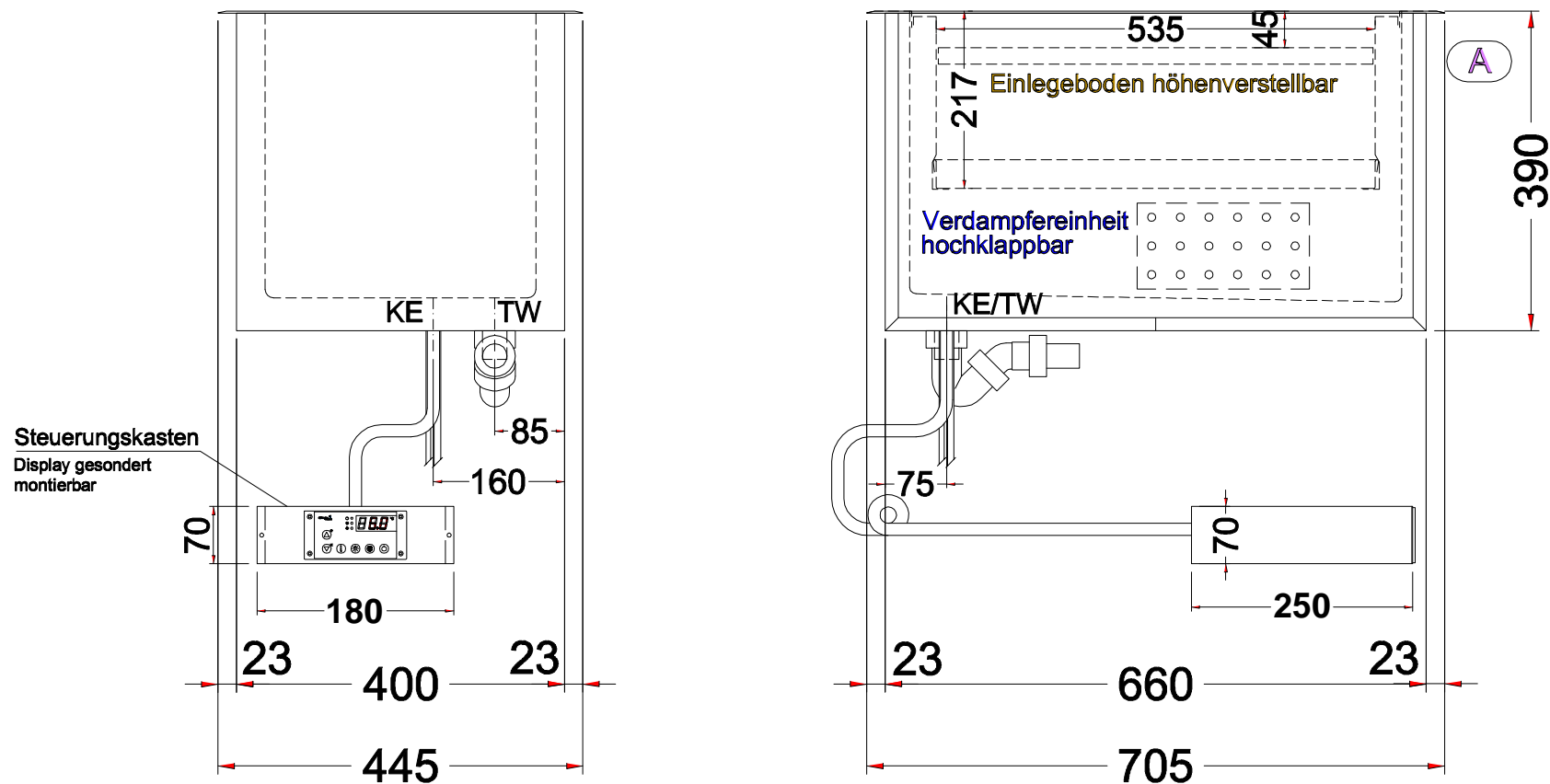

TW = Tauwasserablauf DNØ30
KE = Kälte-Elektro

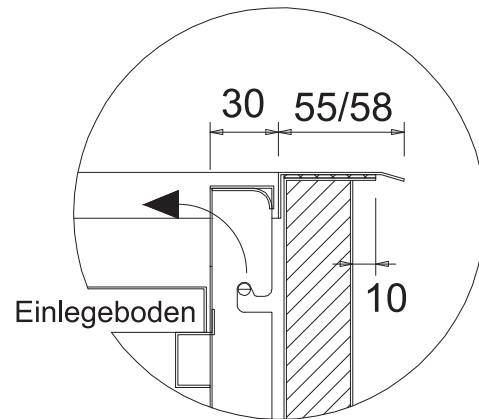

Detail A:

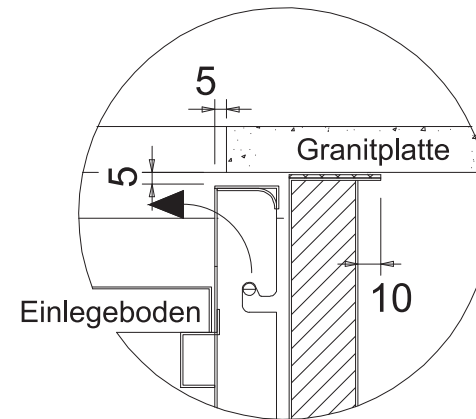

Detail A: Granitunterbau

