

Masszeichnung Einbaukühlwanne UKW 5/1-Z

[Art. 484253827]

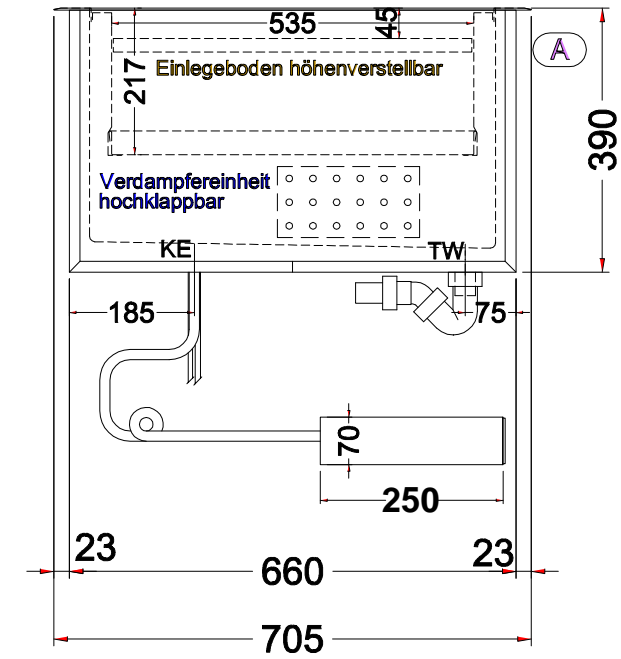

TW = Tauwasserablauf DNØ30
KE = Kälte-Elektro

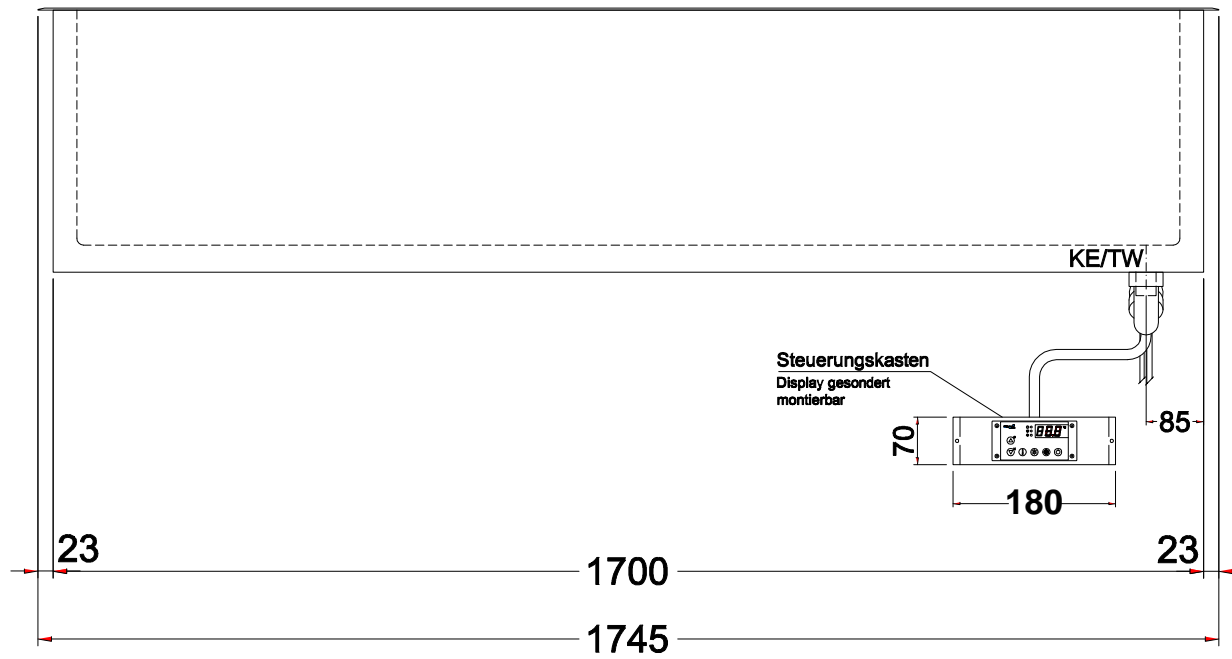
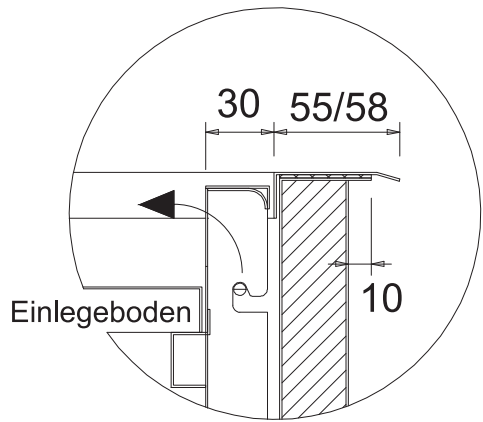

Detail A:

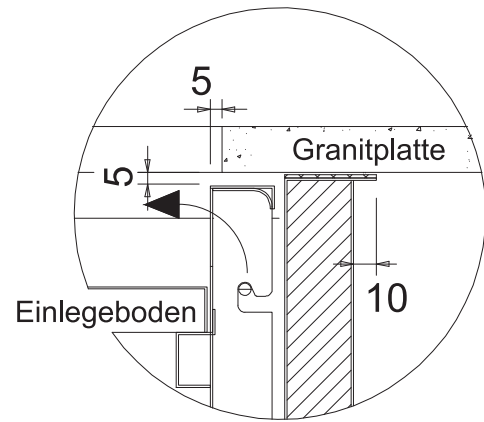

Detail A: Granitunterbau

